

UPPER CRETACEOUS AND TERTIARY INVERSION TECTONICS IN THE WESTERN PART OF THE RHENISH-WESTPHALIAN COAL DISTRICT (FRG) AND IN THE CAMPINE AREA (N BELGIUM)¹

by

H.G. ROSSA²

(40 figures)

RESUME.- L'inversion tectonique crétacée est comparée entre la partie occidentale du Massif houiller du Rhin-Ruhr et le bassin de Campine.

Felder et coll. ont déjà décrit des changements latéraux de faciès résultant d'une inversion du Graben de Roermond dans le Crétacé supérieur de Campine et du Limbourg. La présente étude a permis d'en étudier les mécanismes et leur datation.

L'inversion tectonique a débuté au Cénomaniens au Turonien, culminé du Coniacien au Campanien, atténué au Maestrichtien et Tertiaire inférieur. En Campine, l'inversion est succédée de façon très irrégulière par un affaissement normal qui a largement neutralisé l'effet de l'inversion antérieure en dehors du graben. Dans la partie occidentale du Massif houiller Rhin-Ruhr, les effets de l'halokinèse permienne et l'inversion crétacée sont comparés.

Il y a apparemment un lien étroit entre les effets de la déformation cimmérienne antérieure et l'inversion ultérieure.

ABSTRACT.- This study deals with the Upper Cretaceous to Early Tertiary inversion tectonics in the western part of the Rhenish-Westphalian coal district and the coal exploration area of the Campine.

Whereas Felder *et al.*, provide arguments for lateral facies changes as a result of inversion of the Rur Valley Graben, elements for the mechanisms and timing of this inversions are described in this paper.

Inversion tectonics possibly started in the Cenomanian, certainly in the Turonian, culminated in the Coniacian to Campanian, gradually decreased in the Maastrichtian and Lower Tertiary. In the Campine inversions were succeeded in an irregular way by normal faulting, which practically neutralized the effect of the previous inversions beyond the Rur Valley Graben. For the western part of the Rhenish-Westphalian coal district halokinesis and inversion are compared.

The occurrence of inversion tectonics is clearly linked to earlier extensional Kimmerian movements.

1.- SEPARATE DEPOSITIONAL AREAS DURING THE UPPER CRETACEOUS

The Krefeld High separates the depositional area of the Münsterland Cretaceous to the right of the Rhine from various depositional areas to the left of the Rhine, among which the Limburg Cretaceous (Arnold & Thiermann, 1978; fig. 1).

The Münsterland Cretaceous forms part of the overburden (1) overlying the Carboniferous of the

Rhenish-Westphalian Coal District. The deposits range from the Albian up to the Campanian, whereby in the west of the Rhenish-Westphalian

¹ Lecture and receipt of the manuscript on December 2, 1986. Paper printed with the gratefully acknowledged financial support of Geofiles, Tervuren.

² Prakla-Seismos A.G., P.O. Box 510530, 3000 Hannover 51, Federal Republic of Germany.

(1) «Overburden» or cover rock here always used in the sense of the German «Deckgebirge».

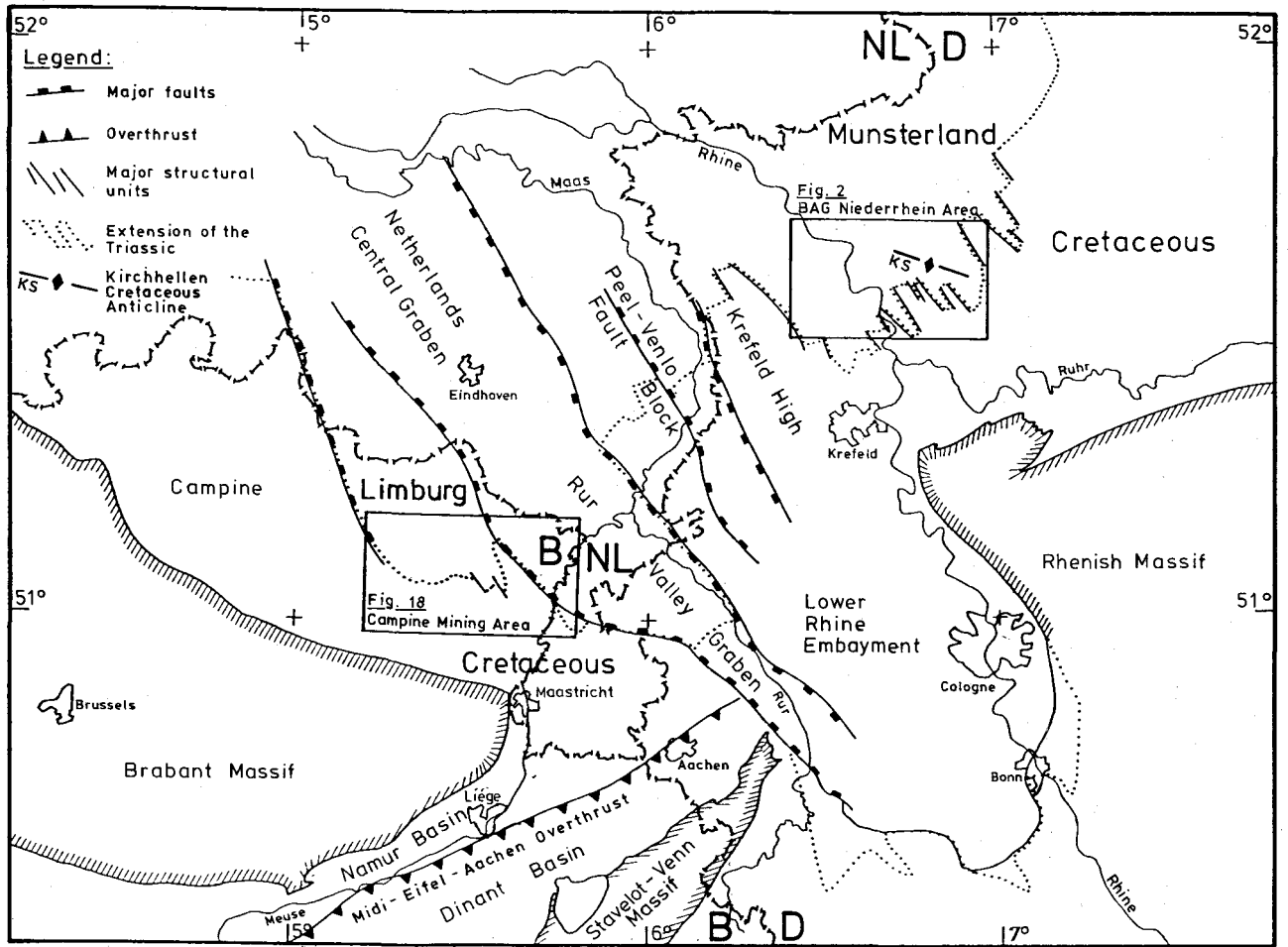

FIG. 1.- Location map showing the depositional areas of the Limburg Cretaceous extending over Lower and Middle Belgium and the Netherlands and the Munsterland Cretaceous north of the Rhenish Massif.

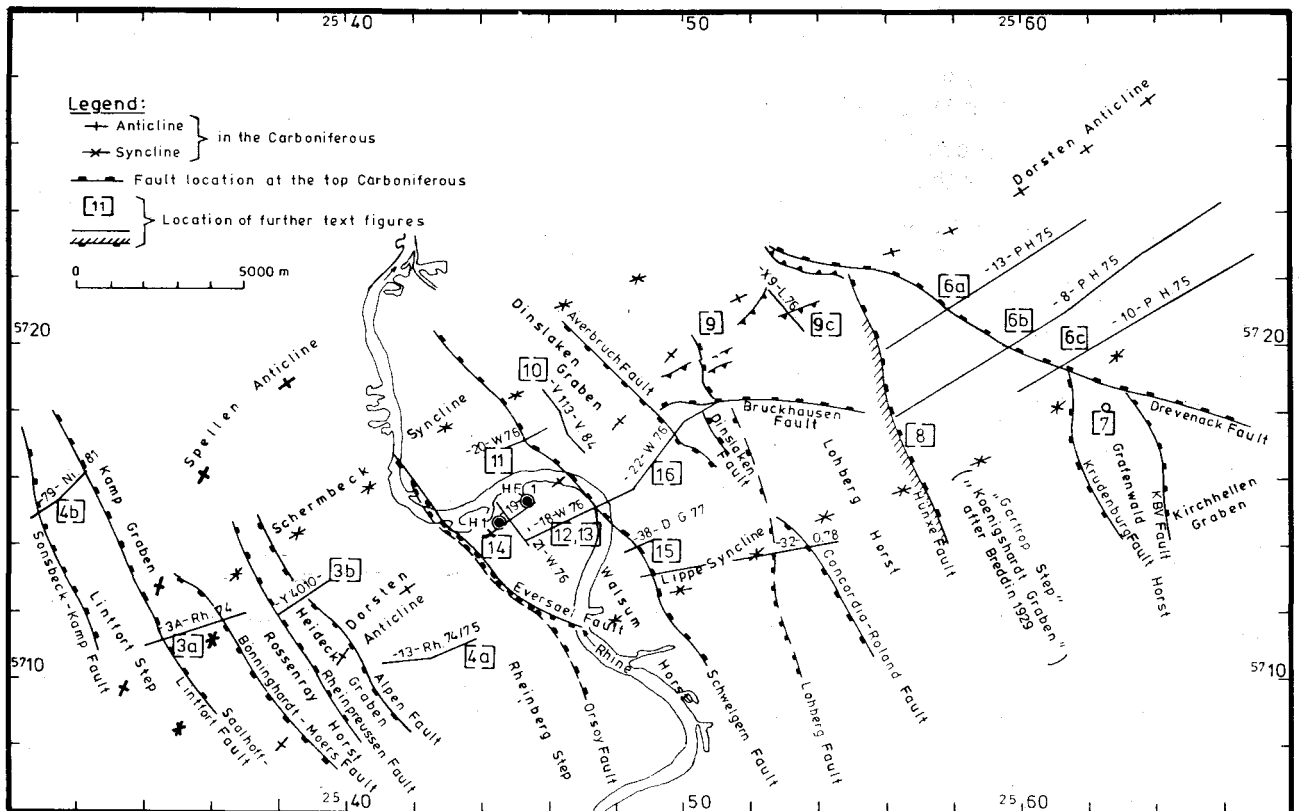

FIG. 2.- Tectonic overview in part of the BAG Niederrhein district.

Coal District, in the area of BAG Niederrhein (2), the Upper Cretaceous succession generally terminates with the Santonian, locally Lower Campanian. Upper Campanian deposits occur only in the eastern and northern parts of the Münsterland Cretaceous. A sedimentation gap is obvious from the Lower Campanian up to the Middle Oligocene.

The Limburg Cretaceous is younger. It outcrops in southern Limburg and in the Aachen area, and has been drilled in north-east Belgium. Around Aachen it corresponds to the Upper Santonian, Campanian and Maastrichtian. Further to the North (in South-Limburg and Belgium) the sequence starts either in the Santonian (?) or in the Campanian whereas also Danian and the transition to the clastic Tertiary are present. In both areas the occurrence of Upper Cretaceous to Early Tertiary inversion tectonics is interesting because of the relationship to pre-Cretaceous post-Dogger (Late Kimmerian) and pre-Mesozoic/post-Westphalian (Saalian? or Asturian) tectonics.

2.- UPPER CRETACEOUS INVERSION TECTONICS IN THE RHENISH-WESTPHALIAN COAL DISTRICT

2.1.- EARLY OBSERVATIONS

Upper Cretaceous inversion tectonics have acquired a long tradition in the discussion on the geology of the Rhenish-Westphalian Coal District because the existence of Late Cretaceous inversion movements was known here already at the turn of the century.

The discovery of these inversion movements began after it had become obvious that the Carboniferous abrasion surface uniformly dips to the north at $2^{\circ}22'$ in the east of the coal district and at $1^{\circ}49'$ in the west. This information has been put to good use for a long time in the mining operations for determining the overburden thickness.

H. Mentzel (1903) described it as follows :

«Infolge der Gleichmässigkeit, mit der sich die ebene Oberfläche des Steinkohlengebirges unter dem Deckgebirge hin erstreckt, kann man im grössten Teil des Bezirks mit Sicherheit voraussagen, in welcher Teufe man beim Schachtabteufen oder bei Tiefbohrungen die Mergelgrenze (3) finden wird. Nur selten weicht das Ergebnis von der Berechnung ab. Alle diese Fälle fasst man im Ruhrbezirk unter dem Namen 'Mergelabstürze' (4) zusammen.»

Originally, the Upper Cretaceous inversion tectonics had been described in the literature as «Mergelabsturz» («Marl downfall», Mentzel, 1903). Mentzel (1903) recognized the relationship between the inverse movements and older, normal faults in the Carboniferous :

«Im ganzen macht das Profil des Streckenstosses den Eindruck, als ob die alte vorkretacäische Blumenthaler Verwerfung später in nachkretacäischer Zeit noch einmal aufgerissen wäre und den inzwischen abgelagerten Mergel mit in Bewegung gebracht hätte. Da der Mergel nordöstlich von der Störung angefahren wurde, diese selbst aber südwestliches Einfallen besitzt, muss die Richtung der zweiten Bewegung der ersten Verschiebung entgegengesetzt gewesen sein. ... Andere Mergelabstürze mögen auch unmittelbar durch Verwerfungen hervorgerufen worden sein.»

Moreover, Mentzel (1903) accepted the possibility that some of the «Mergelabstürze» might have been caused by «less resistant surfaces of the Carboniferous strata more truncated than the more resistant ones».

Also Pilz (1906) recognized reversed movements along normal faults which had taken place after deposition of the Cretaceous sediments.

Löscher (1929) was the first to recognize the slightly 'folded structures' in the southwestern part of the Münsterland Cretaceous. This 'folded structure' nowadays plays an important part in evaluating the inversion tectonics (see section 2.5.1 and fig. 6).

Breiddin (1929) produced the first significant summary - no longer just individual observations - of the knowledge gained about the Upper Cretaceous inversion tectonics and prepared a map of observations from numerous concession wells (= Mutungsbohrungen) drilled at the turn of the century. He replaced the expression «Mergelabsturz» for inversion movements by «fault reversal» (= Umkehrverwurf). As only the base of Cretaceous was mapped and different Cretaceous layers were not compared with each other, Breiddin assumed this Cretaceous tectonics to be of Laramian age.

Also later authors, among which Kukuk (1933) and Wolansky (1960) referred to inverse movements in the overburden on top of the Carboniferous.

2.2.- OBSERVATIONS IN NW GERMANY

In NW Germany, where large scale mining activities do not exist, inversion movements during the Upper Cretaceous were naturally not discussed at such an early stage.

As a result of oil exploration cross-sections produced from boreholes became more common

(2) The BAG Niederrhein is the western-most of the three mining companies which make up the Ruhrkohle AG.

(3) Miners refer to the layers of the Upper Cretaceous as «Mergel». In the eastern part of the Rhenish-Westphalian Coal District they alone form the overburden above the Carboniferous.

(4) Mergel downfalls.

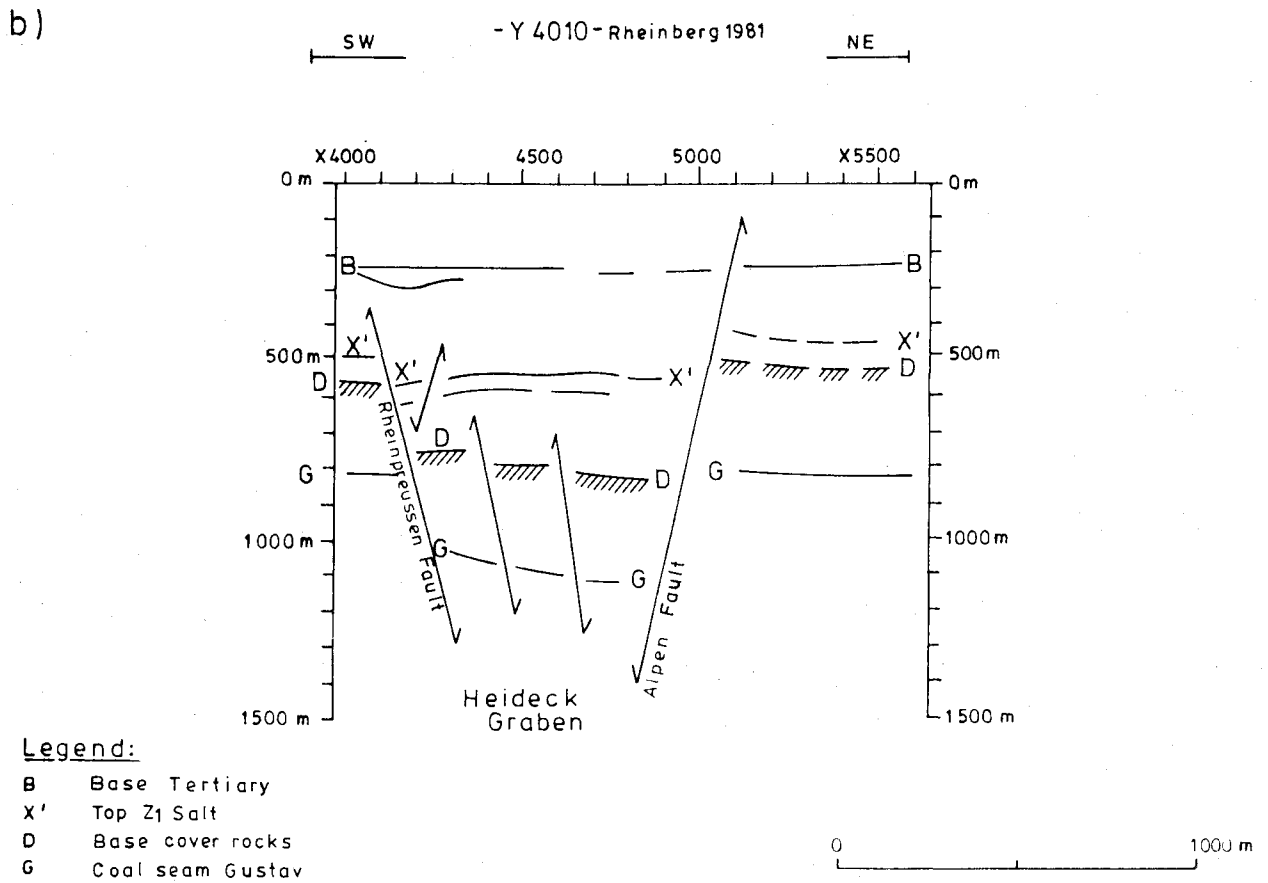
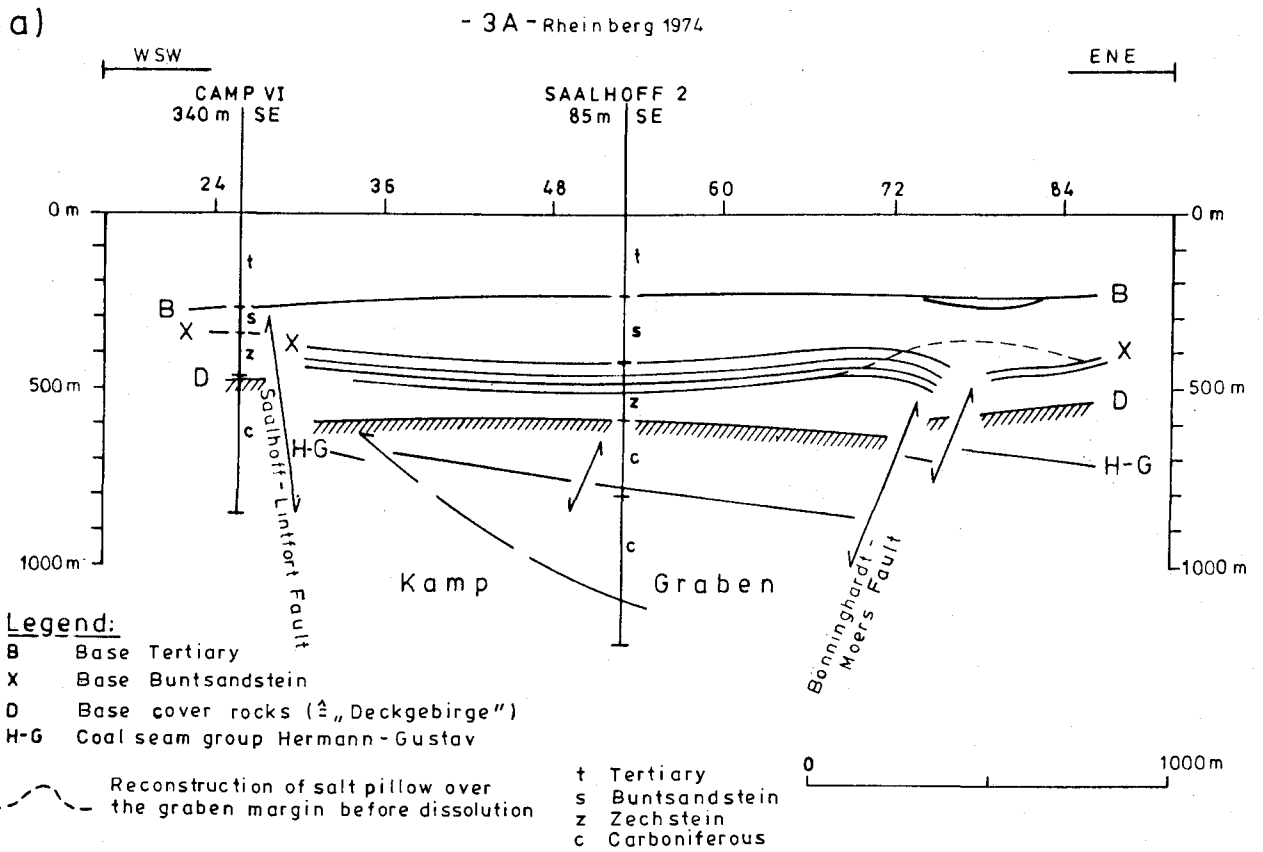

FIG. 3.- Dependence of salt migration on graben width.

in the literature since the beginning of the '60s; these cross-sections clearly show inversion movements during the Upper Cretaceous. Söll (1962) described the thickness variation of the Upper Cretaceous, which indicates inversions. However, he did not mention them.

Eichenberg (1969) on the other hand did mention that «These occurrences are a result of the Subhercynian-Laramian downward movement of the upthrown block».

According to Voigt (1962) the Turonian-Coniacian deposits near Halle (Teutoburger Wald) contain intercalations of older Turonian formations which do not outcrop in the adjacent part of the upturned southwestern flank of the Teutoburger Wald Anticline. Voigt assumed that these different facies originated from the raised and eroded north-east flank of the Teutoburger Wald Anticline.

Voigt (1963) referred to «Subhercynian (to Laramian) inversion». He did not limit this expression to the individual faults. Rather he referred to the reversal of the subsidence tendency of entire basins, such as the Lower Saxony Basin, the southern boundary of which is the Teutoburger Wald.

Voigt (1970) concluded that «in the Upper Cretaceous of Westfalen a certain local instability of the sea floor» is present.

Boigk (1969) also used the term «inversion» which subsequently has become generally accepted.

Ziegler (1982) interpreted Upper Cretaceous and Early Tertiary inversion movements as a consequence of Alpine folding. An account of inversion structures in northwestern Germany has been presented by Baldschuhn, Frisch & Kockel (1985).

2.3.- THE SIGNIFICANCE OF SEISMIC SURVEYS FOR RECOGNIZING INVERSION TECTONICS IN THE RHENISH-WESTPHALIAN COAL DISTRICT

Seismic surveys have been carried out in the '50s and '60s by the then separate companies of PRAKLA GmbH and SEISMOS GmbH which used the technique of single-fold coverage. But even so the existence of different directions of fault movement was recognized.

From 1974 onwards seismic surveying was continuously employed since the foundation of the Ruhrkohle AG. Initially 2D seismics with multiple coverage was applied, and since 1975 also 3D seismics. The value of seismics for mine planning rapidly increased. Soon it was realized that the

nature of the overburden had an important bearing on the mining.

On 8.3.1979 a symposium was held at the BAG Niederrhein in Duisburg-Homberg on «Tectonic movements in the overburden in the BAG Niederrhein mining area and their effects on the tectonics in the Carboniferous». The observations here below were originally presented at that symposium.

2.4.- POST-CARBONIFEROUS DEPOSITIONAL HISTORY

In the BAG Niederrhein area the overburden consists of Zechstein, Trias, Cretaceous and Tertiary deposits. The thickest sequences of Zechstein and Trias are preserved in NNW-SSE striking grabens, which have been explored by seismic surveys since 1974 (fig. 2).

2.4.1.- Zechstein

The BAG Niederrhein area is situated at the southern margin of the Zechstein depositional basin. The Werra Salt wedges out to the south where it is completely absent. The remaining layers, including the Z4 cycle, often do not exceed 100 m.

In the southern part, especially on the horsts, the pre-Upper Cretaceous erosion is responsible not only for the dissolution of the salt but also for the formation of a dissolution collapse breccia which negatively affects the seismic resolution of the underlying Carboniferous deposits.

The Werra salt completes the sequence towards the north, at least in the grabens. Outward salt migration distinguishes the larger grabens (such as the Kamper Graben; 2 km wide) from the smaller ones (such as the adjoining Heidecker Graben; 1 km wide), where no salt migration is observed (fig. 3) (5). On the NNW-SSE striking fault blocks, especially west of the Walsum Horst, salt pillow type deformations occur along the fault block axes. These, however, have not been caused by salt migration but rather resulted from leftover salt masses after dissolution. Along these axes the top of the salt deposit occasionally remains parallel to its base indicating that the original thickness of the salt deposit has been preserved there. Towards the fault block edges the salt gradually decreases in thickness and eventually disappears (fig. 4a). Fluid circulation along the faults is seen as the main dissolution mechanism. In cases of prolonged

(5) The location of figs. 3-16 is indicated on fig. 2.

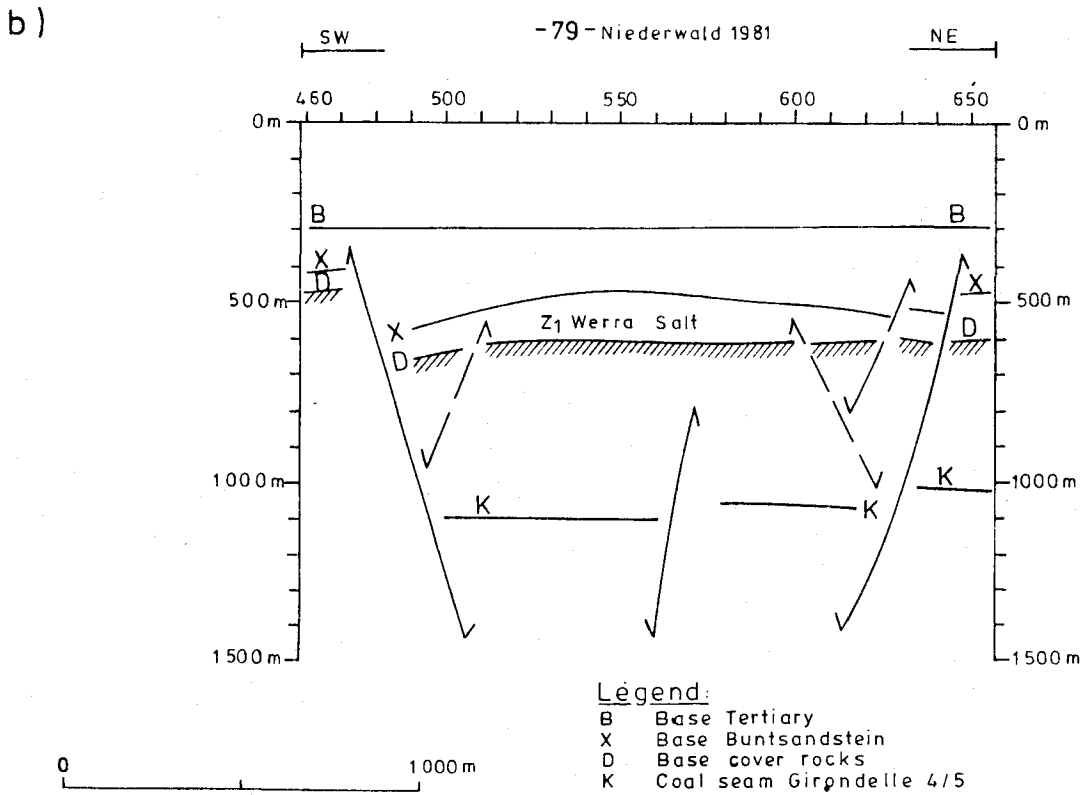
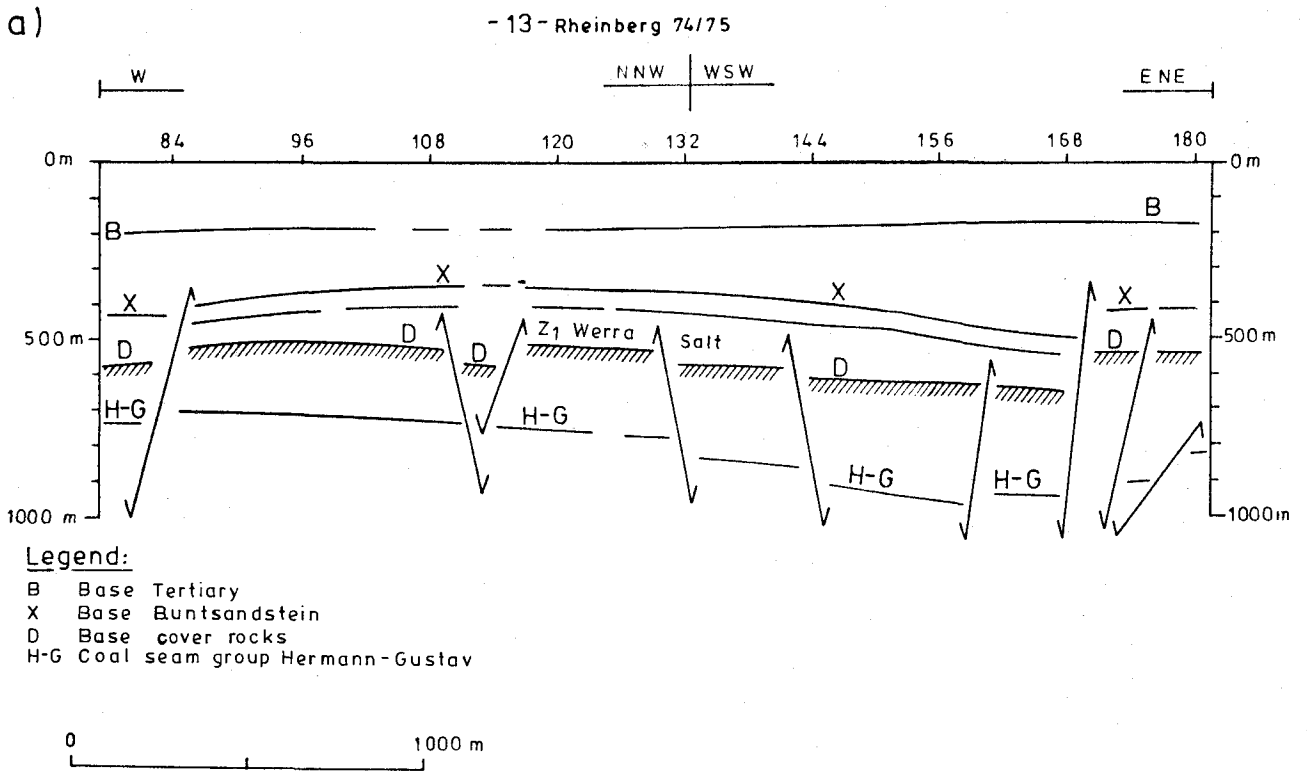

FIG. 4.- Dissolution of the Z₁Werra Salt starting from fractures.

dissolution or on narrow fault-blocks the original conformity between top and base of the salt has been completely destroyed resulting in an hour-glass like swell, as observed on seismic sections, which might be misinterpreted as salt pillows (fig. 4b).

If the salt thickness is less at the fault-block edges, dissolution is the responsible mechanism. On the other hand salt migration normally starts with a downward movement of the top salt in the graben centre and accumulation at the edges. The greatest accumulations (salt pillows by definition) often occur on the horst side of the fault-block margin. These may then collapse as a result of further dissolution (cf. 2.4.2. and fig. 3a).

2.4.2.- Trias

The Trias of the BAG Niederrhein area usually consists of the Lower and Middle Buntsandstein, completed towards the north by the Upper Buntsandstein. Upper Buntsandstein, Muschelkalk and also Keuper occasionally occur on the horsts close to the margins. Presumably all these places once witnessed salt accumulation on the uplifted fault block. Subsidence resulting from early dissolution of these salt pillows was then matched by sediment infilling (cf. 2.4.1.). The Mesozoic sequences become more complete towards the north and may include the Lower Jurassic (fig. 5). In this way a Late Kimmerian age can be established for the formation of the main fault blocks, which probably represent reactivated older faults (of Saalian ? or Asturian age). This is clearly the case where the fault throw is more important within the Carboniferous than at the base of the overburden. Buntsandstein and underlying Zechstein deposits continue east of the BAG Niederrhein area into the Marl Graben in the BAG Lippe area, but quickly wedge out on the adjoining eastern block. The Marl Graben also contains Mesozoic sediments and associated inversion tectonics similar to the grabens within the BAG Niederrhein area (fig. 5).

2.4.3.- Cretaceous

The Lower Cretaceous (Albian) is generally limited in thickness to a few metres only. It is also tectonically related to the Upper Cretaceous.

The Upper Cretaceous starts with the Walsum Sands of Cenomanian age and ranges up to the Santonian or Lower Campanian in the surveyed area. The major part of this study deals with the structural deformation of the Cretaceous, which is essential for the recognition of inversion tectonics.

2.4.2.- Tertiary

Tertiary sequences normally start with Middle Oligocene deposits. Only in the westernmost part

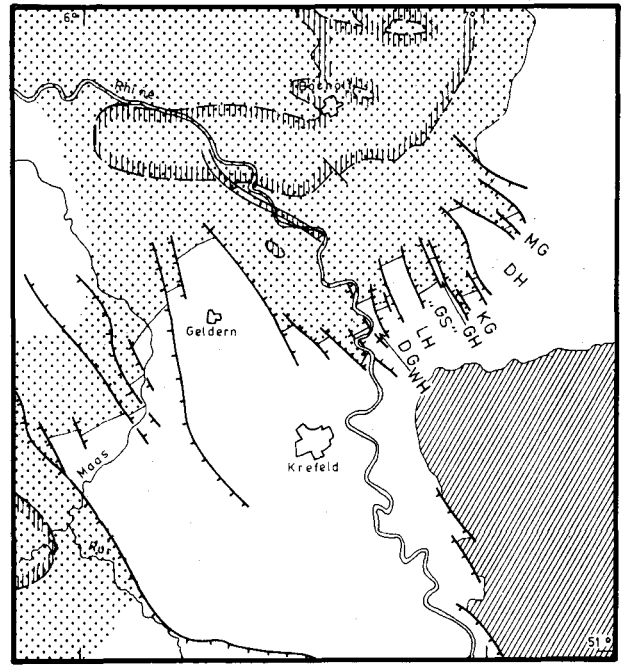

Legend:

TTTTT	Lias subcrop	WH	Walsum Horst
.....	Buntsandstein subcrop	LH	Lohberg Horst
////	Pre Upper Carboniferous outcrop	GH	Grafenwald Horst
		DH	Dorsten Horst
0	2000m	DG	Dinstaken Graben
		„GS“	„Gartrop Step“
		KG	Kirchhellen Graben
		MG	Marl Graben

FIG. 5.- Distribution of older Mesozoic deposits after W. Knauff (1978), amended.

these are underlain by the Paleocene. Tertiary beds decrease in thickness towards the east and wedge out before reaching the eastern limit of the BAG Niederrhein. In the other direction, west of the Walsum Horst, the Upper Cretaceous wedges out underneath the Tertiary, which then overlies the Buntsandstein (locally the Zechstein) or even directly rests on the Carboniferous.

Some small normal faults were observed. These are reactivated Late Kimmerian faults (fig. 11). Occasionally collapse structures may occur resulting from the dissolution of Zechstein salt along faults. Channel-like incisions cut by the Old Rhine may be observed.

2.5.- CHARACTERISTICS OF INVERSION TECTONICS

2.5.1.- Reconstruction of the original fault-throws and direction of movement

The WNW-ESE striking Drevenack Fault forms a major tectonic feature in the BAG Niederrhein area (fig. 2). Its throw over a broad fracture zone attains 850 m within the Carboniferous, but is reduced to 150-200 m at the base of the overburden.

a)

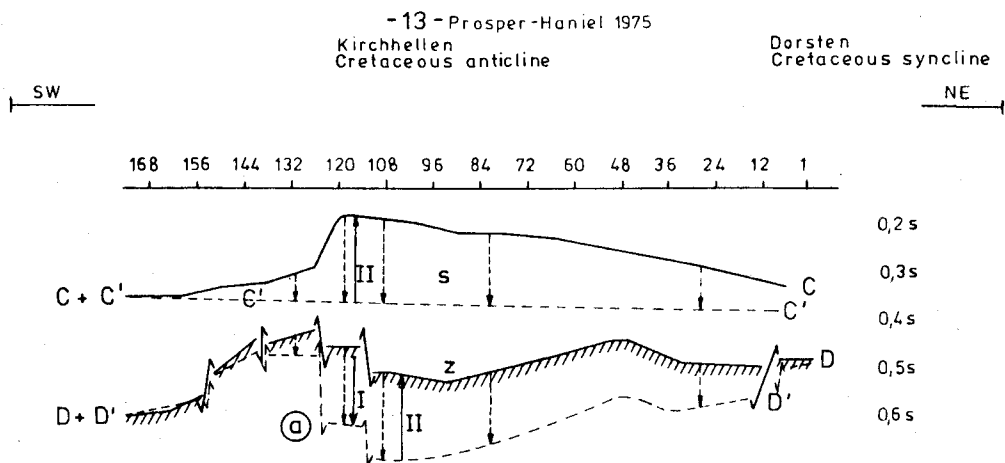

b)

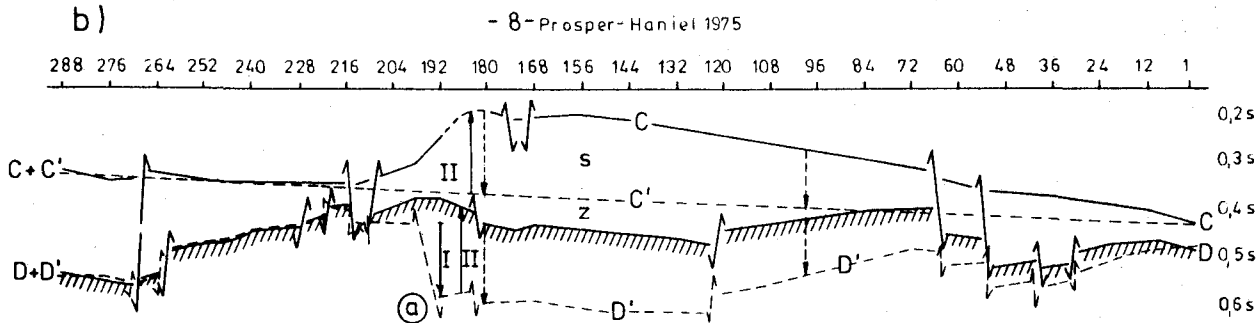

c)

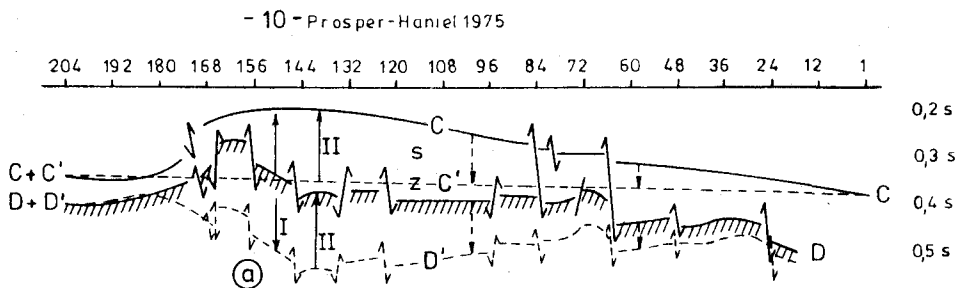

Legend:

- C Base Upper Cretaceous
- D Base cover rocks
- s Buntsandstein
- z Dissolution breccia Zechstein
- (a) Drevenack Fault

- CC' = DD'
- I 1 Late kimmeric movement
- II 2 Upper Cretaceous movement

0 2000m

C' and D' Location of horizon C and D at the onset of the Upper Cretaceous

FIG. 6.- Three sections across the Drevenack Fault.

Figure 6 shows parts of three seismic time sections which cross the Drevenack Fault. Horizon C forms the base of the Upper Cretaceous, Horizon D the top of the Carboniferous, here covered by Buntsandstein and a Zechstein dissolution breccia. The uplift of Horizon C corresponds to the Kirchhellen Cretaceous Anticline (fig. 1) (6) whose southern flank coincides with the Drevenack Fault. The uplift of Horizon C to its actual anticlinal position constitutes the inversion at the Drevenack Fault. The position of Horizon C during its deposition (now slightly tilted towards the east) can be obtained by joining the end points of Horizon C on the seismic sections (dashed line C' on fig. 6). Horizon D can then be relocated by moving it down by the same amount to Horizon D', which represents its position at the time of deposition of Horizon C. The Drevenack Fault appears more clearly now.

The Late Kimmerian deformation along the Drevenack Fault (a) can be described as a tilt of Horizon D along a horizontal rotating axis which lies north-east of the profiles and strikes parallel to the fault (movement I). During the Upper Cretaceous Horizon D almost returned to its original position, whereas Horizon C was uplifted into the asymmetric Kirchhellen Anticline (movement II). The steep south limb - partly upthrust - overlies the Drevenack Fault. The more gentle and straight north limb slopes downwards to the rotating axis in the hinge line of the reactivated fault block. In this way the Kirchhellen Anticline forms a smaller and concealed replica of the «Teutoburger Wald» (cf. 2.2). However, the concealed Kirchhellen Anticline still possesses its north limb.

2.5.2.- Indications of inversion tectonics in the Carboniferous basement

2.5.2.1.- Flexuring instead of displacement along the existing fault plane

Figure 7 shows a section through the coal seam group Chriemhilt 1 to Chriemhilt 2/3 in the Grafenwald Horst. The small fault zone «f» strikes parallel to the Drevenack Fault, which forms the northern boundary of the Grafenwald Horst.

The earlier normal fault and the later inversion are evident. It becomes clear that the inversion does not consist of a single reverse movement along the fault plane but rather forms a curving uplift on the fractured part of the original downthrown block. A weaker uplift also can be discerned on the upthrown block near the fault «f». The maximum inversion movement exceeds the previous downthrow (see dashed line and arrow at the northern end of the section, fig. 7a).

The selective effect of the inversion leads to the assumption that the downthrown block was fractured to a greater extent than the upthrown block during the Late Kimmerian activity (fault f).

2.5.2.2.- Steeper dips in the Carboniferous accompanying stronger inversions

Figure 8a results from a survey of the Upper Cretaceous inversion at the Hünxe Fault, which forms the eastern limit of the Lohberg Horst (fig. 2). Basic information was provided by earlier seismic lines with single-fold coverage. Their location is indicated by the position of measured observation points.

The schematic section of figure 8b clarifies the meaning of the symbols used. The bulge which rises several metres above the base Cretaceous crosses the Hünxe Fault zone.

The uplift of the originally downthrown block (Horizon D in lowest position) varies. And it is highest near the Bruckhausen Fault which is marked by a strong inversion.

Whereas the dip of the Carboniferous strata, as illustrated by Coal Seam P, is essentially horizontal to the west of point A in fig. 8c, it markedly increases in front of the strongest inversion. Then the dip remains constant across a small reverse fault until the Hünxe Fault (point B; investigated by horizontal drilling).

2.5.2.3.- Asturian thrust faults reactivated as Cretaceous reverse faults

Some SW-NE striking Asturian thrust faults occur on the Carboniferous upthrown block adjacent to the inverted Drevenack Fault (fig. 9). Due to the inversion tectonics these were reactivated as reverse faults displacing the top Carboniferous, the Bunter and occasionally the base Cretaceous.

2.5.2.4.- Wedge formation at the margin of the upthrown block

The formation of small reverse faults at the margins of upthrown blocks of an inverted fault zone is a characteristic feature in several places. These faults wedge out in the direction of the upthrown block (see fig. 8-9; reverse faults parallel to the Hünxe and Drevenack faults).

These reverse faults probably extend downwards and merge with the old fault zones forming a wedge in the upper part of the basement near the margin of the upthrown blocks. These wedges are slightly raised in comparison with the major portion of the upthrown blocks farther away from the margin. The formation of these wedges proves that compressional forces were involved in the inversion.

2.5.2.5.- Masking of old faults by inversion

A fault zone farther north in the Dinslaken Graben has been interpreted as the continuation

(6) Towards the north and the south of the Kirchhellen Cretaceous Anticline additional parallel striking Cretaceous axes are known.

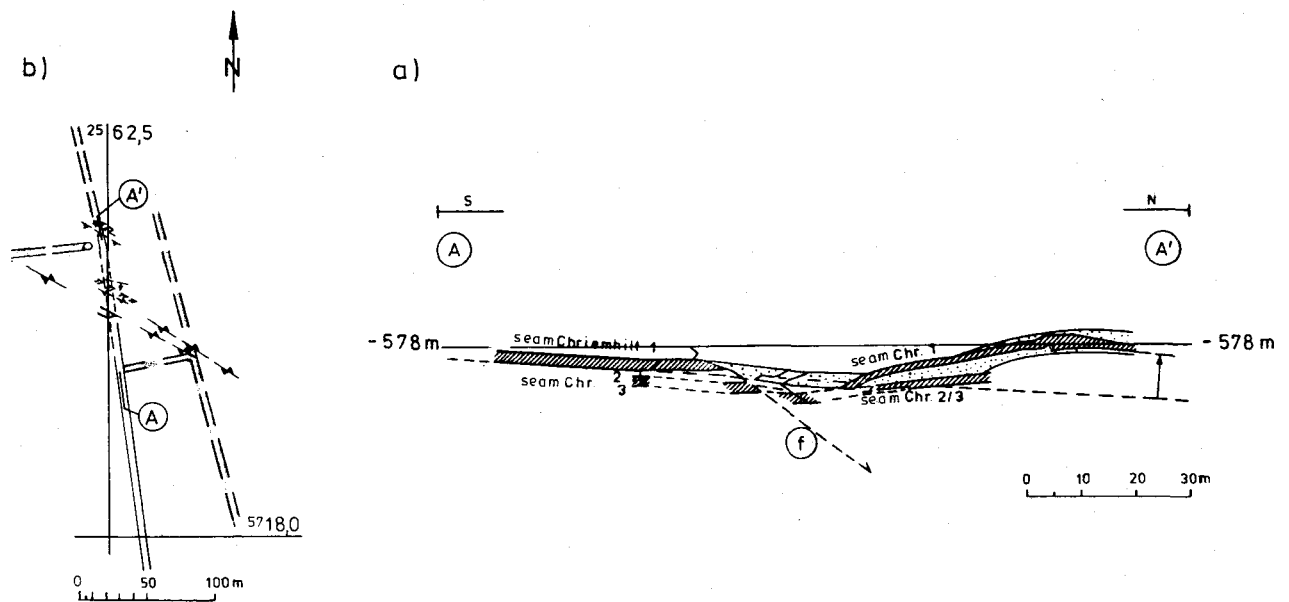

FIG. 7.- Section through coal seam group Chriemhilt in the Grafenwald Horst.

of the Bruckhausen Fault recognized on the Lohberg Horst (cf. fig. 2, 8a and 10).

Werra Salt has been preserved on the northern block - the downthrown block of the Late Kimmerian Fault (fig. 10). Inversion tectonics have created a warping of the overburden on the northern fault block.

On the time section (fig. 10a) a fault is not discernible in the Carboniferous or at the base overburden. However, a fault with small throw appears in the depth section (fig. 10b). The inversion almost equals the original downthrow. The repeated fracturing has probably affected a larger zone.

2.6.- FAULTING AFTER DEPOSITION OF THE BASE TERTIARY

At the base Tertiary in the BAG Niederrhein area normal faults, always with very small throws, can be observed only occasionally. Figure 11 shows a cross-section through the Schwelgern Fault, the eastern boundary of the Walsum Horst.

The large Schwelgern Fault is made evident by Horizon D, the base overburden. A Bunter horizon (S) is shown on the downthrown block. The Upper Cretaceous horizons between its base (C) and top (B) indicate the Upper Cretaceous inversion in a range which is not restricted to the old fault but which includes the adjacent parts of the upthrown and downthrown blocks.

Four small normal faults with the same direction as the original Schwelgern Fault can be observed at the base Tertiary. These faults cover the entire zone moved inversely during the Upper Cretaceous on either side of the Schwelgern Fault. Despite the good reflection quality the faults could not be recognized in the underlying Cretaceous horizons.

Maybe the base Tertiary (which was subhorizontal before faulting : Horizon B') was slightly extended by the faulting. Originally, the Upper Cretaceous reflectors had a steeper dip (Horizon C'). A slight regional extension may have been compensated for by the backward tilting from the steeper dip to the flatter one (pers. comm. G.H.W. Nijenhuis, Prakla-Seismos AG).

2.7.- AGE OF THE UPPER CRETACEOUS INVERSION TECTONICS

Figure 12 depicts the Upper Cretaceous horizons across the Schwelgern Fault. The positions of the Walsum Horst, Dinslaken Graben and Schwelgern Fault are shown (fig. 16a). It was fortunate that in this section several reflection horizons in the Upper Cretaceous could be tied on either side of the Schwelgern Fault.

Horizon 1 (= C) represents the base Upper Cretaceous, horizon 9 (= B) the base Tertiary. The thickness change of the sequence between the Horizons 2 and 5 indicates an eastward dip of the entire horst-graben system. Arrows of equal length above and below this sequence show that parallel bedding, i.e. uniform subsidence during

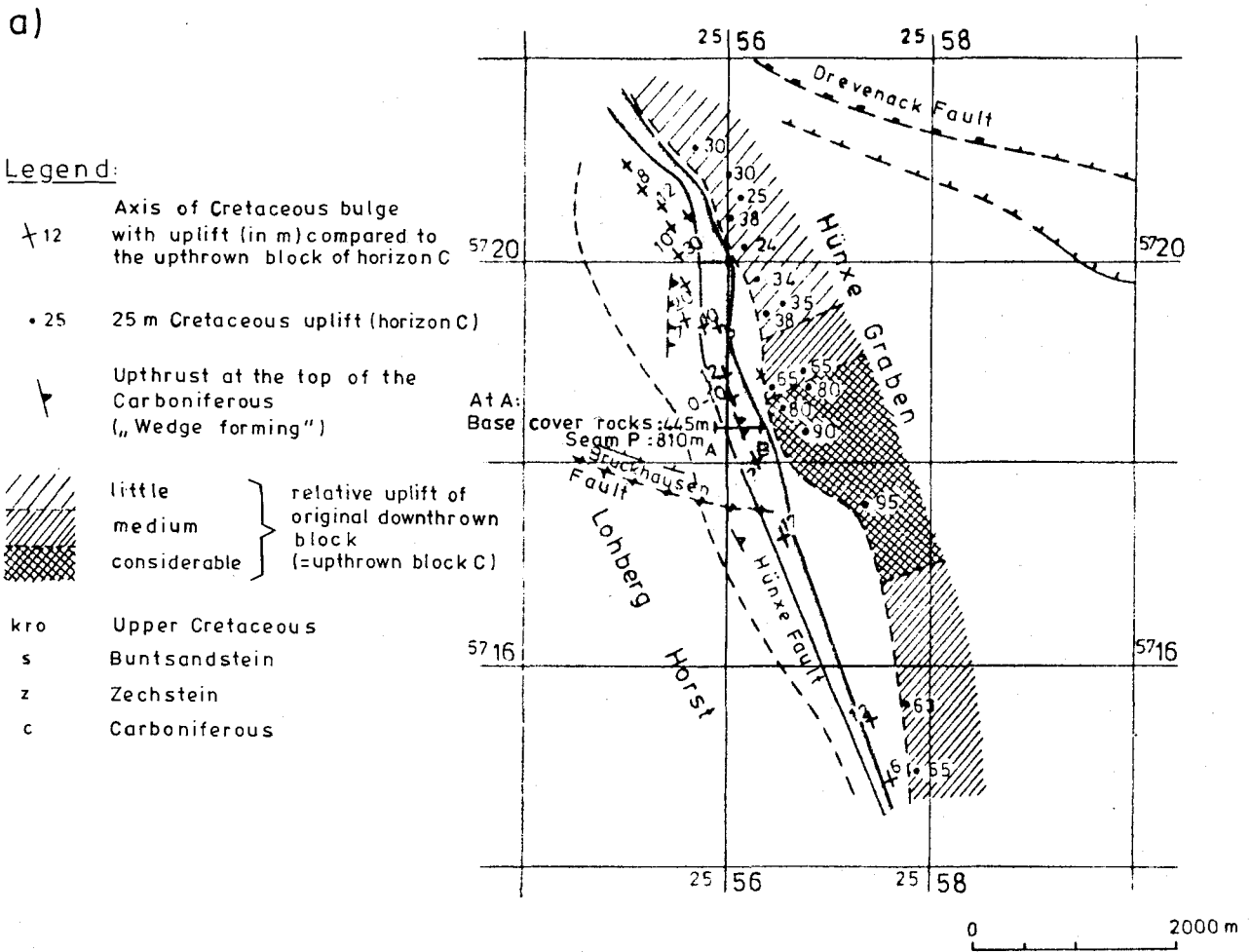

b) Schematic Sketch

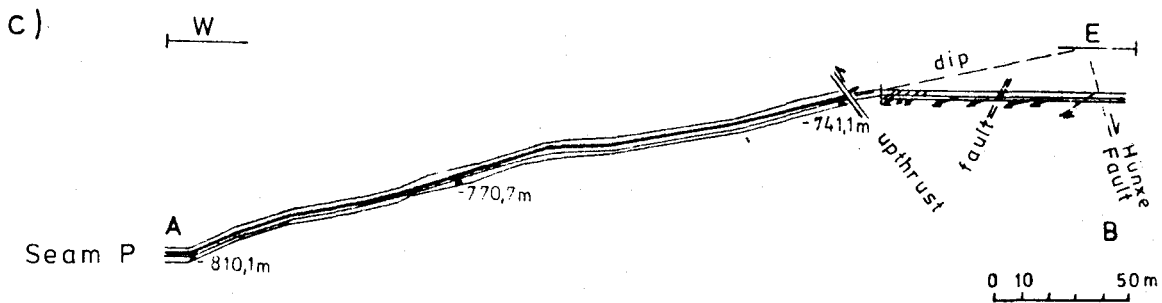
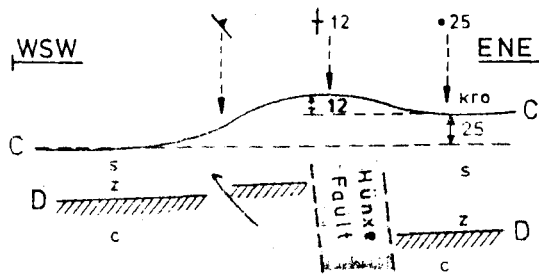
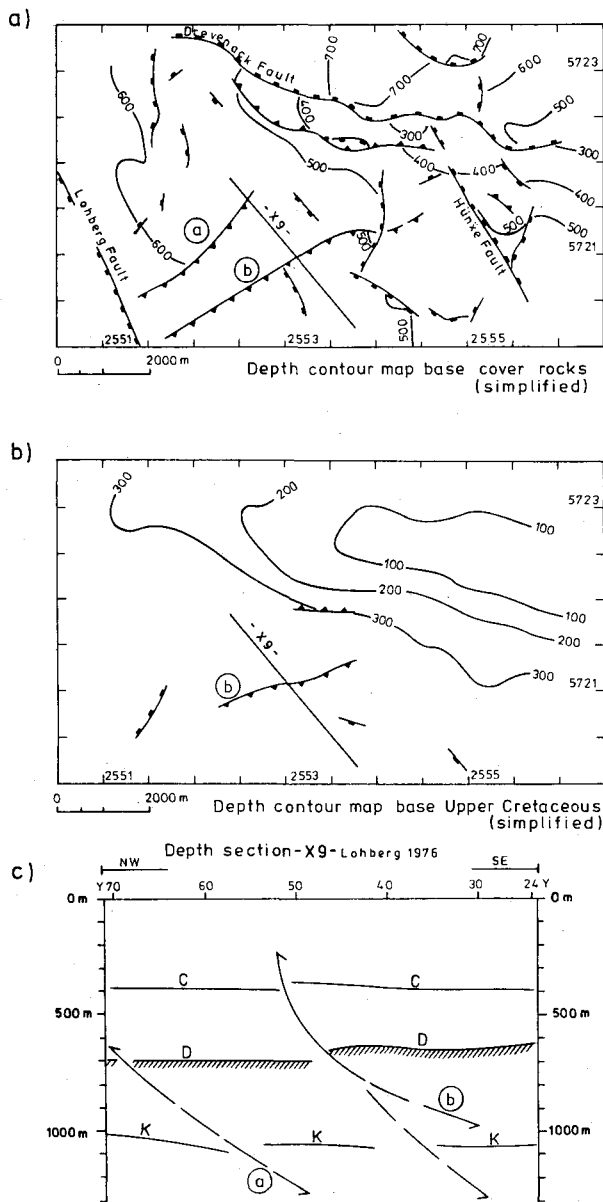

FIG. 8.- Inversion at the Hünxe Fault.



Legend:

Depth in meters

C Base Upper Cretaceous

D Base cover rocks

K Coal seam Katharina

FIG. 9.- Cretaceous reverse faults as reactivation of asturic thrusts.

deposition existed above the Walsum Horst as well as above the Dinslaken Graben. Arrows of different length on either side of the Schweigern Fault show that during the Upper Cretaceous the Walsum Horst subsided more rapidly than the Dinslaken Graben.

Figure 13 shows the same sequence as figure 12. However, the Horizons 1 to 9 have been plotted inversely (7) in figure 13, i.e. Horizon 1 no longer lies at the bottom but instead at the top at 0 m depth (= Horizon 1_i). This horizon has been smoothed, and subsequent horizons follow at the corresponding thickness intervals. Horizon 9_i is the deepest horizon of the inversely (therefore i)

plotted sequence (8). At the very bottom Horizon 1 (= C) has been plotted once again in real position (fig. 12).

In this type of display all the horizons 1_i to 9_i as well as Horizon 1 (= C) represent Horizon C, though in each case at different geological times. Position 1_i represents Horizon C during its approximately horizontal deposition. Horizon C came in the position of Horizon 2_i at the time when Horizon 2 was deposited horizontally near the surface. This display can be used because it is unimportant whether the depth difference is plotted from top to bottom or vice versa. Horizon C was buried deeper with geological time. The inverse plot stops with Horizon C at position 9_i (corresponding more or less with the base Tertiary). Since then Horizon C has been buried yet deeper until its actual position at 1 (= C).

Horizon C bulged above the Schweigern Fault as a result of salt migration as early as the deposition time of Horizon 2. Accordingly the bulge originated at the start of the Upper Cretaceous inversion. This bulge gradually shifted eastwards to the uplifted block over the Dinslaken Graben (see anticline symbols on fig. 13) as a result of the increasing thickness over the Walsum Horst. The eastward dip originated during deposition of horizons 2 to 5 as is evident from Horizon C in Figure 13.

Of greatest importance in the interpretation of the inversion tectonics, however, is the fact that the inversion process at the Schweigern Fault persisted throughout the existing Upper Cretaceous (fig. 14c). If on Figure 13 the reflection horizons above the Walsum Horst are extended in a straight line below the bulge to the Dinslaken Graben (dashed lines) then a gradually increasing depth difference can be observed between the two blocks (small arrows at geophone position 129) throughout the Upper Cretaceous.

Figure 14a shows the location of line 18 (figs. 12-13) and the connection, via line 21 (fig. 14b), to line 19 (fig. 14c), on which wells Höcht 1 (H1) and Hasselsfeld 1 (HF1) are located. These wells allow a stratigraphic correlation of the interpreted reflections. The sequence ranges from the Cenomanian to the Santonian or Lower Campanian.

In 1977 it was an surprising discovery to have recognized a slow but steady non-orogenic

(7) An inverse plot fortunately cannot be mistaken for inverse tectonics.

(8) An inversely plotted sequence corresponds as it were to a piece of washing, for example a shirt, hanging on a line by the stretched hem to dry and in such a case the normal uppermost part, i.e. the collar, now hangs at the bottom.

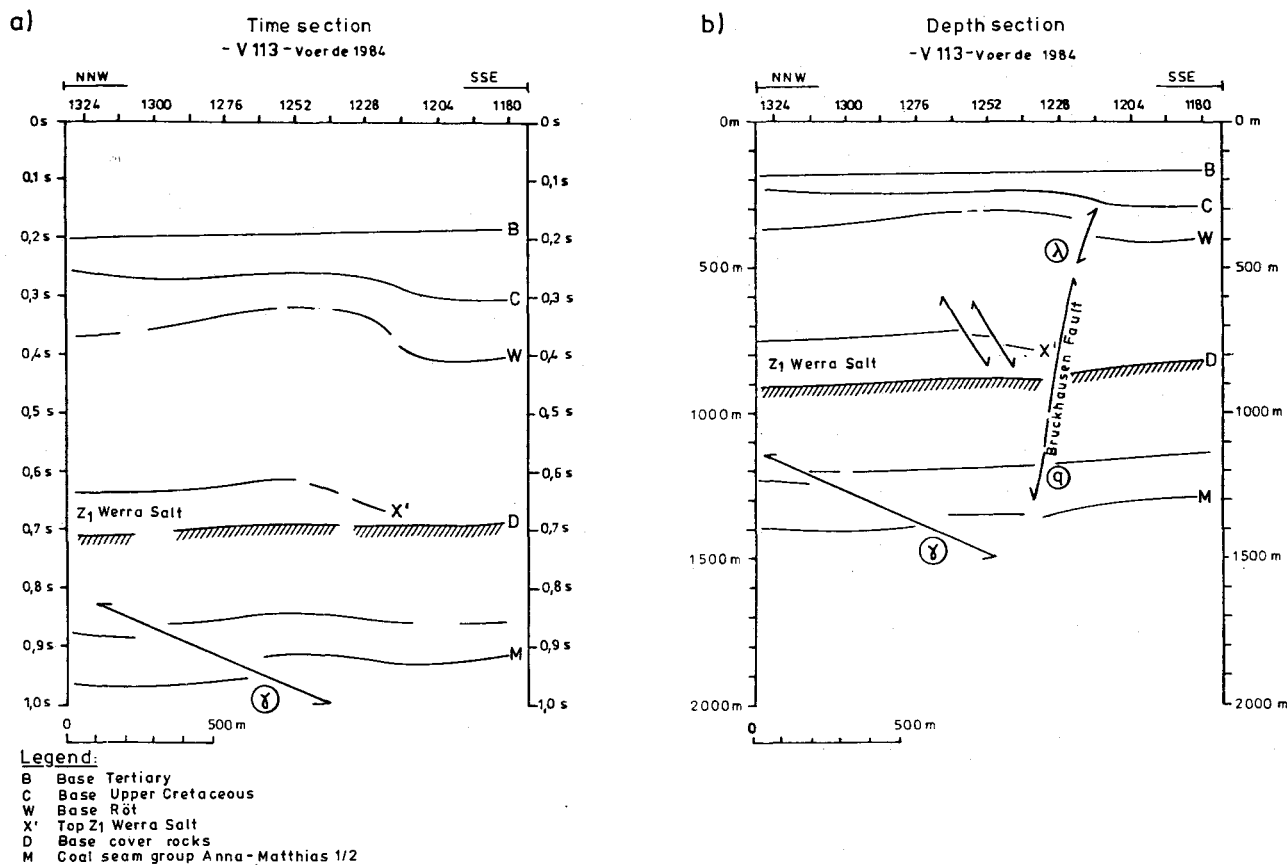

FIG. 10.- Section through the Bruckhausen Fault.

movement responsible for the warping of the Cretaceous horizons over the horst/graben boundaries in the BAG Niederrhein area.

The beginning of the Upper Cretaceous inversion may be inferred from the Krefeld area to the west of the BAG Niederrhein area. Erosion of the Krefeld High during the Upper Cretaceous followed the Lower Cretaceous (Hauterivian) depositional phase (Note that the Upper Cretaceous Krefeld High should be distinguished from the Paleozoic Krefeld High!). Therefore it is assumed here that the Upper Cretaceous Krefeld High is also a result of the inversion tectonics. The Krefeld High may have been formed very early in the Upper Cretaceous. A reduction in thickness from east to west is apparent already in the limestones above the Essen Greensand, i.e. in the Upper Cenomanian (pers. comm. W. Müller, WBK Bochum).

2.8.- NORMAL FAULTING AND INVERSION OCCURRING SIMULTANEOUSLY AT THE SAME POSITION ON A FAULT ?

The Schwelgern Fault was clearly subjected to an inversion during the Upper Cretaceous. However this is not true everywhere. At least at

one place (Osterfeld, line 32, fig. 2) the base Cretaceous was displaced about 45 m in the same direction as the base overburden (200 m). The base Tertiary was also displaced in the same direction (25 m).

At first glance line 38 (fig. 15) (Survey Dinslaken Graben 1977) reveals the same picture : throws in the same direction amount to 320 m at the base overburden, 50 m at the base Cretaceous, and 15 m at the base Tertiary. However, after closer inspection a flexure zone can be recognized in the Cretaceous reflections about 100 m east of the Schwelgern Fault. This can be interpreted as a smaller inversion movement with a thrust of about 10 m. Bunter reflections (fractures) and Upper Cretaceous reflections (flexures) are affected. A slight flexure of the base Tertiary may be doubtful.

Inversion and normal faulting could not have been active at the same time here. Perhaps the inversion movement within the Cretaceous is older here, whereas the difference in throw between the base Cretaceous and base Tertiary was formed in the non-deposition time prior to the Oligocene, i.e. in the uppermost Cretaceous and the lowermost Tertiary.

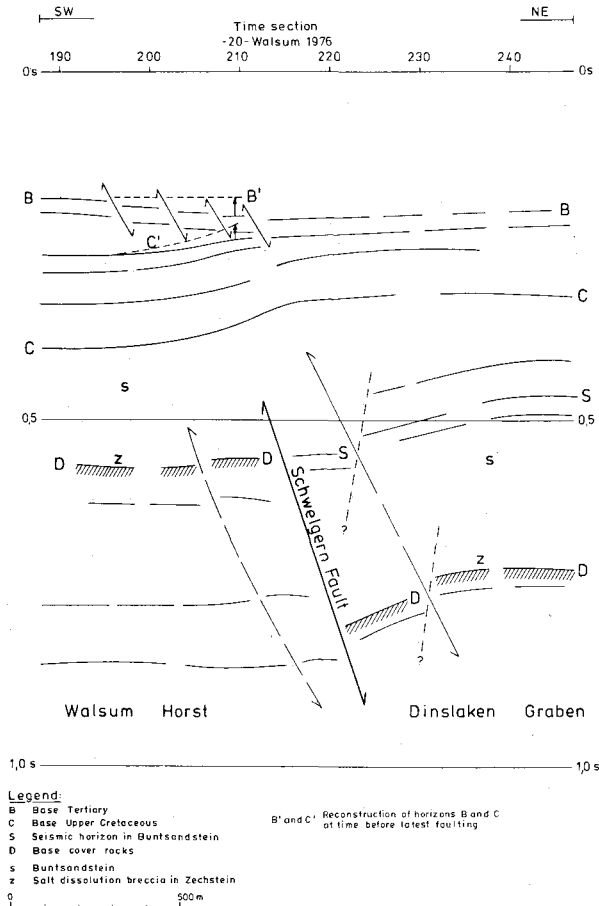

FIG. 11.- Seismic section over the Schwelgern Fault.

2.9.- INVERSION TECTONICS AND THE ZECHSTEIN SALT

The difference in subsidence between the Dinslaken Graben and Walsum Horst as determined from section 18 (fig. 13) is not the true difference. This is obscured by movements of the Werra salt in the Dinslaken Graben.

Figure 16 shows a cross-section through the Dinslaken Graben based on lines 18 and 22 (see location map, fig. 14a). The reflection horizons between the base Upper Cretaceous (Horizon C) and the base overburden (Horizon D), i.e. reflections from the Bunter and Zechstein, are shown. The upward doming of Horizon C seen in figures 12 and 13 can also be recognized in figure 16a.

Horizon C is horizontal between the geophone points 59 and 75 on line 22 in figure 16a. Below this horizontal part of Horizon C the reflections from the Bunter and Zechstein are strongly arched. Obviously the reflection horizon 1 rests on the small horst in the base overburden whose western limit is fault α . As a result of the arching the remaining salt below Horizon 1 stopped

flowing and the overlying sequence up to Horizon C remained stable. Therefore Horizon C was not tilted between geophone points 59 and 75. This section 22, where Horizon C has preserved its horizontal position, shows the real uplift of the Dinslaken Graben during the Upper Cretaceous inversion.

From there Horizon C dips westwards in the direction of the Schwelgern Fault. If this dipping portion of Horizon C is replaced in the horizon C' (fig. 16a) and the deeper horizons 1 to 4 are raised by the same amount to horizons 1' to 4', then the interval between horizons D and 1' (or 2') will increase in thickness towards the graben margin (fig. 16b, cf. area with long arrows in fig. 16a).

Figure 16c shows the variation in thickness between Horizon D and horizon 2'. The increase of the thickness to the WSW is the result of an earlier increasing salt thickness to the graben margin (Schwelgern Fault in fig. 16a). Maybe it should be emphasized here that the reconstruction of Horizon C into its original horizontal position also yields data on the tectonic conditions wherein the deeper deposits of the Cretaceous above the Werra salt have been deposited.

The increasing rate of subsidence of Horizon C away from the subhorizontal portion between geophone points 59-75 in the direction of the Schwelgern Fault forms a measure for the amount of salt squeezed out during the Upper Cretaceous inversion and accumulated at the graben margin. The squeezing out of the Werra salt is also indicated by the bulging in Horizon C above the Schwelgern Fault. This feature also originated during the Upper Cretaceous inversion (chapter 2.7, fig. 13). This salt accumulation at the graben margin increases northwards.

2.10.- CONCLUSIONS

The Upper Cretaceous inversions can be best investigated in the western part of the Rhenish-Westphalian coal district because they are most conspicuous there.

In the BAG Niederrhein area Upper Cretaceous inversion movements are tied to previous faults, but presumably zones wider than the actual faults are involved. Perhaps these correspond to weakness zones around the faults. In general it appears that the downthrown block of the faults has been fractured more intensely.

Greater inversions are associated with the large faults at the horst/graben boundaries. On the other hand, the small faults within the horsts and grabens were subjected to inversions with only small displacements. The inversion stress had a selective effect.

Depth section
- 18 - Walsum 1976

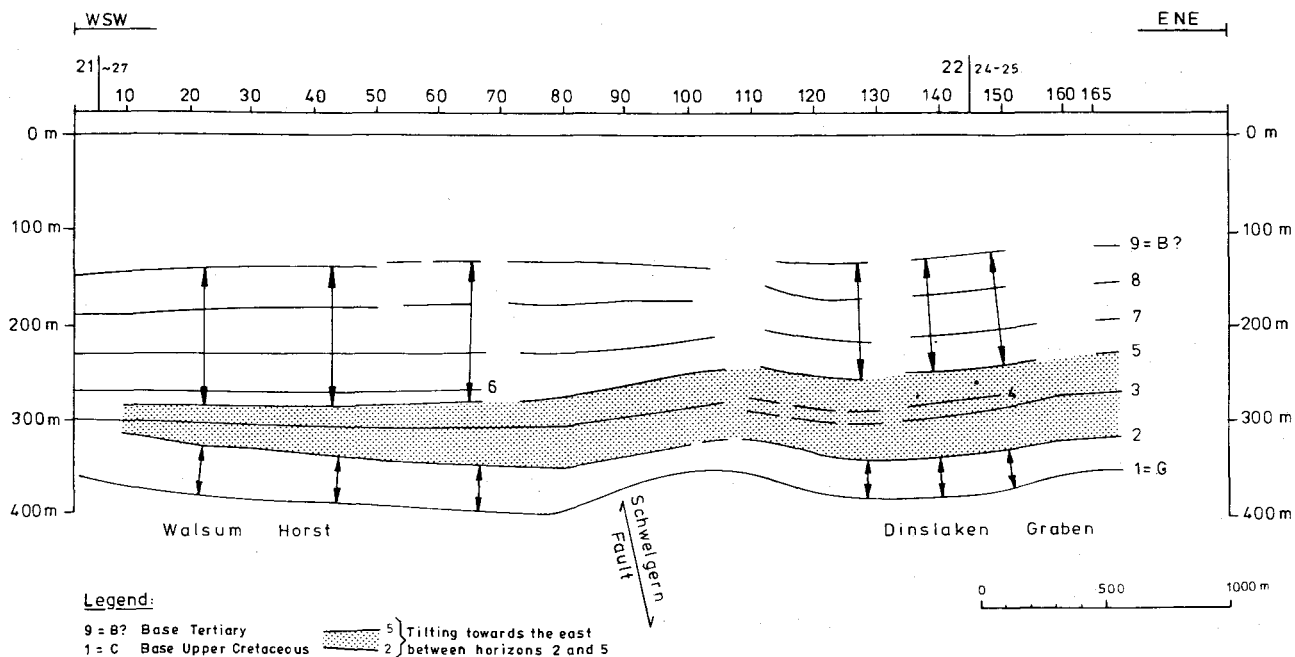

FIG. 12.- Section showing the Upper Cretaceous seismic horizons over the Schwelgern Fault.

- 18 - Walsum 1976

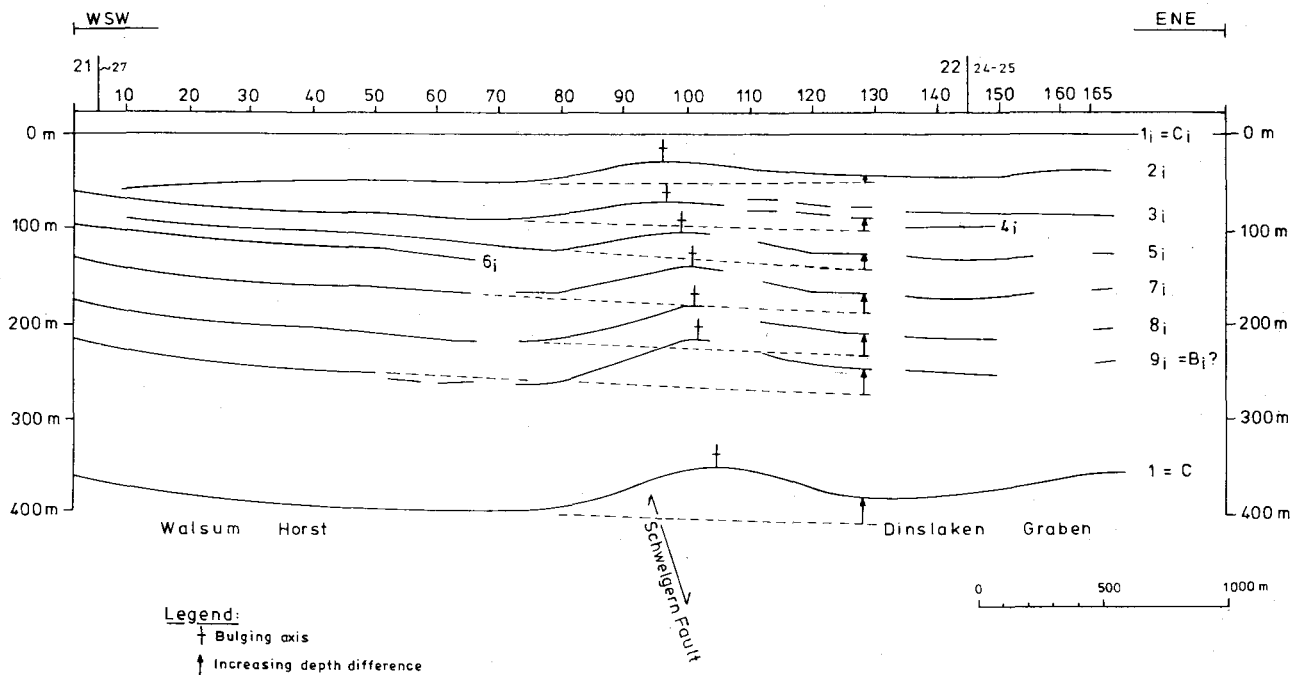

FIG. 13.- Inverted plot of the same Upper Cretaceous seismic horizons as in Fig. 12.

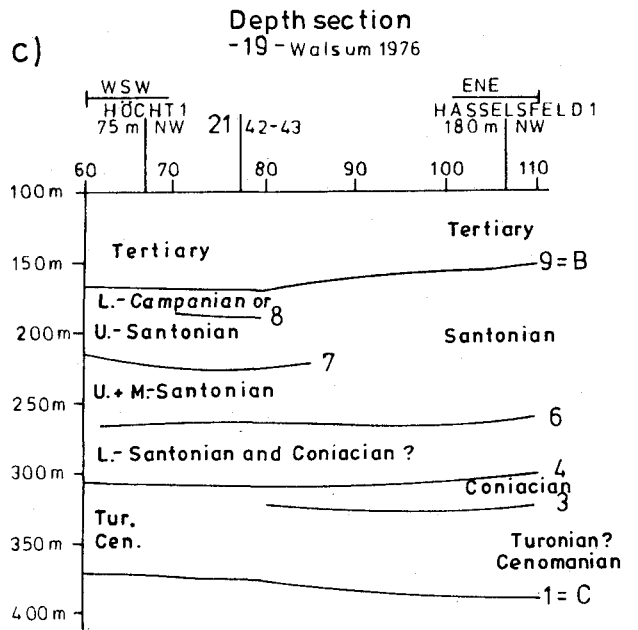
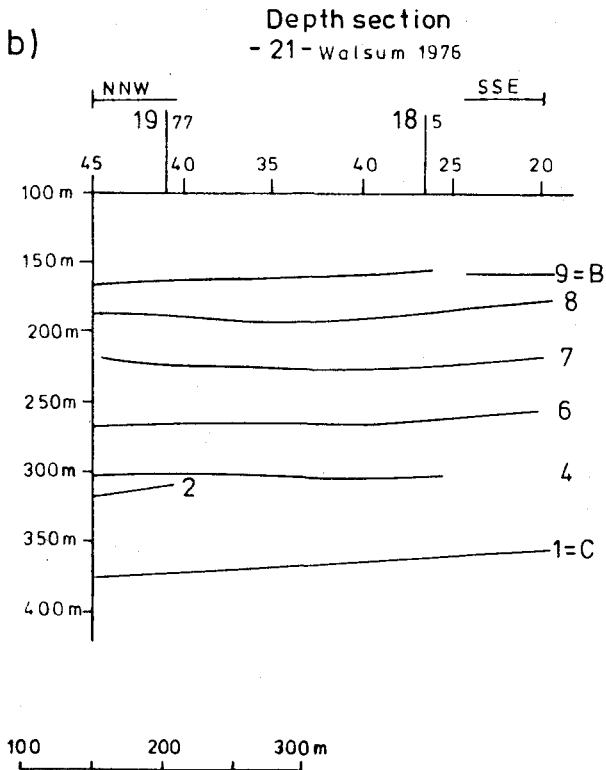
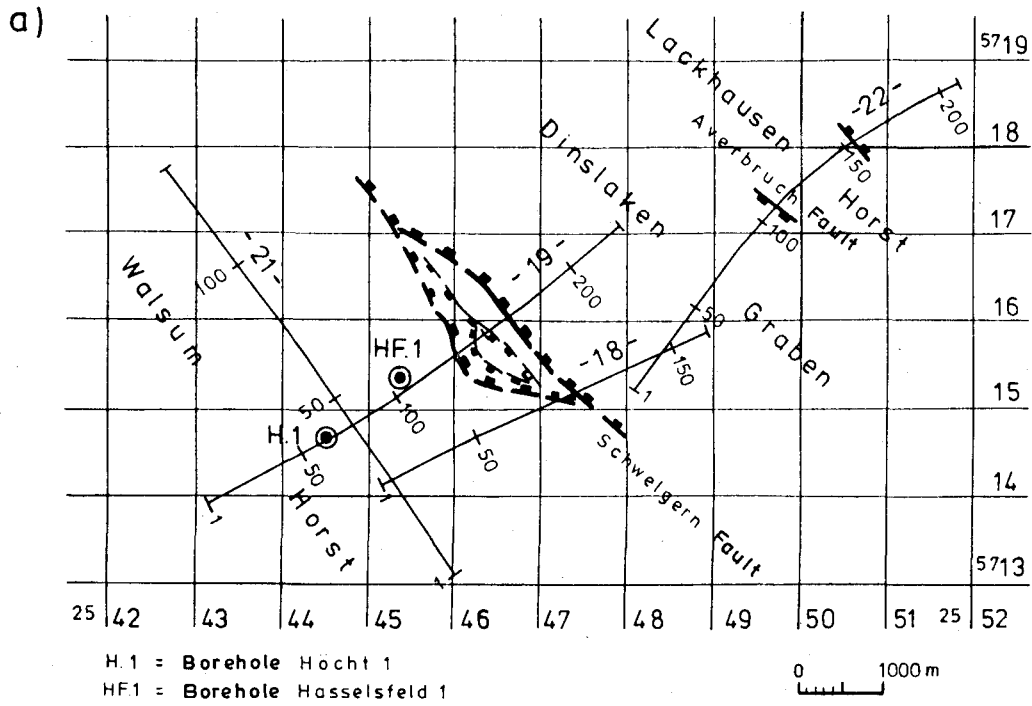

FIG. 14.- Location map of seismic profiles 18, 19, 21 and 22
Identification of reflections based on well data.

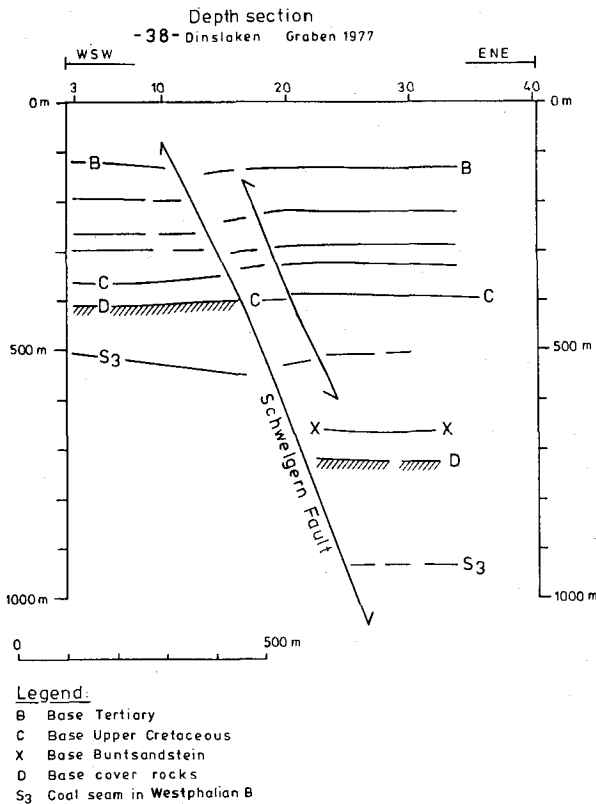

FIG. 15.- Downthrow and inversion in the Upper Cretaceous.

During the inversion period the stress affected complete tectonic blocks (horsts and grabens) because inversion movements can be recognized at all positions where small, older normal faults existed in these regions. The inversion movements are long-lasting events and involve compression. The numerous flexures that have been observed can best be explained by continuous stress. Updoming in the Upper Cretaceous suggests movement of existing salt accumulation during the inversion.

Faults with a Hercynian (WNW-ESE) direction (e.g. Drevenack Fault, Bruckhausen Fault) have been particularly affected by inversions. In the Teutoburger Wald to the north slickensides have a preferential direction perpendicular to this Hercynian direction.

Not all the NNW-SSE striking faults exhibit inversion movements. Inverse movements may have passed into normal fault movements along the same fault. The transition from inversion (compression) to normal faulting (tension) at any one position on a fault (cf. 2.8., fig. 15) may indicate that one or both blocks were affected by tilting.

Inversion movements with important uplifts extend eastward to the Marl Graben. Large inversions are obviously tied to the margins of the

large Triassic downthrows, i.e. to the Late Kimmerian orogeny (fig. 5). This was already suggested by Breddin (1929).

Numerous NNW-SSE striking faults exist also to the east of the Marl Graben with important throws in the Carboniferous and small inversions in the Upper Cretaceous. Inversion movements with large displacements are unknown in the east, where flexuring does not exist. Breddin (1929) distinguished the area with complex Cretaceous fault-fold tectonics in the western Rhenish-Westphalian coal district (up to the Marl Graben) from the area to the east with more simple fault tectonics. The absence of important inversion movements in the eastern Rhenish-Westphalian coal district is explained by the more intense Carboniferous folding which seems to have offered greater resistance to deformation by inversion tectonics. In the western area this intensely folded Carboniferous occurs to the south of the here mapped area.

Apparently the large NNW-SSE striking normal faults of Variscan origin have not (or at least to a less extent) been affected by the Late Kimmerian orogeny in the eastern area.

If the large inversion movements are indeed tied to the Late Kimmerian normal faults and almost absent along the older Variscan normal faults, one might assume that the fracture zones along the Late Kimmerian faults were less consolidated than those around the older faults during the inversion.

3.- UPPER CRETACEOUS-TERTIARY INVERSION IN THE BELGIAN CAMPINE

The Campine region in northeastern Belgium conceals a Carboniferous coal basin. The coal-bearing Carboniferous deposits range into the Westphalian D. Since 1979 geological exploration by means of boreholes and reflection seismics is going on in front of the mining basin. Single coverage seismic surveys were already carried out during the fifties.

3.1.- THE OVERBURDEN

The cover of the Carboniferous locally consists of a marginal Zechstein (without salt), and a Buntsandstein to Lias sequence, truncated by an Upper Cretaceous to Tertiary sequence spreading a blanket over all older formations (fig. 17).

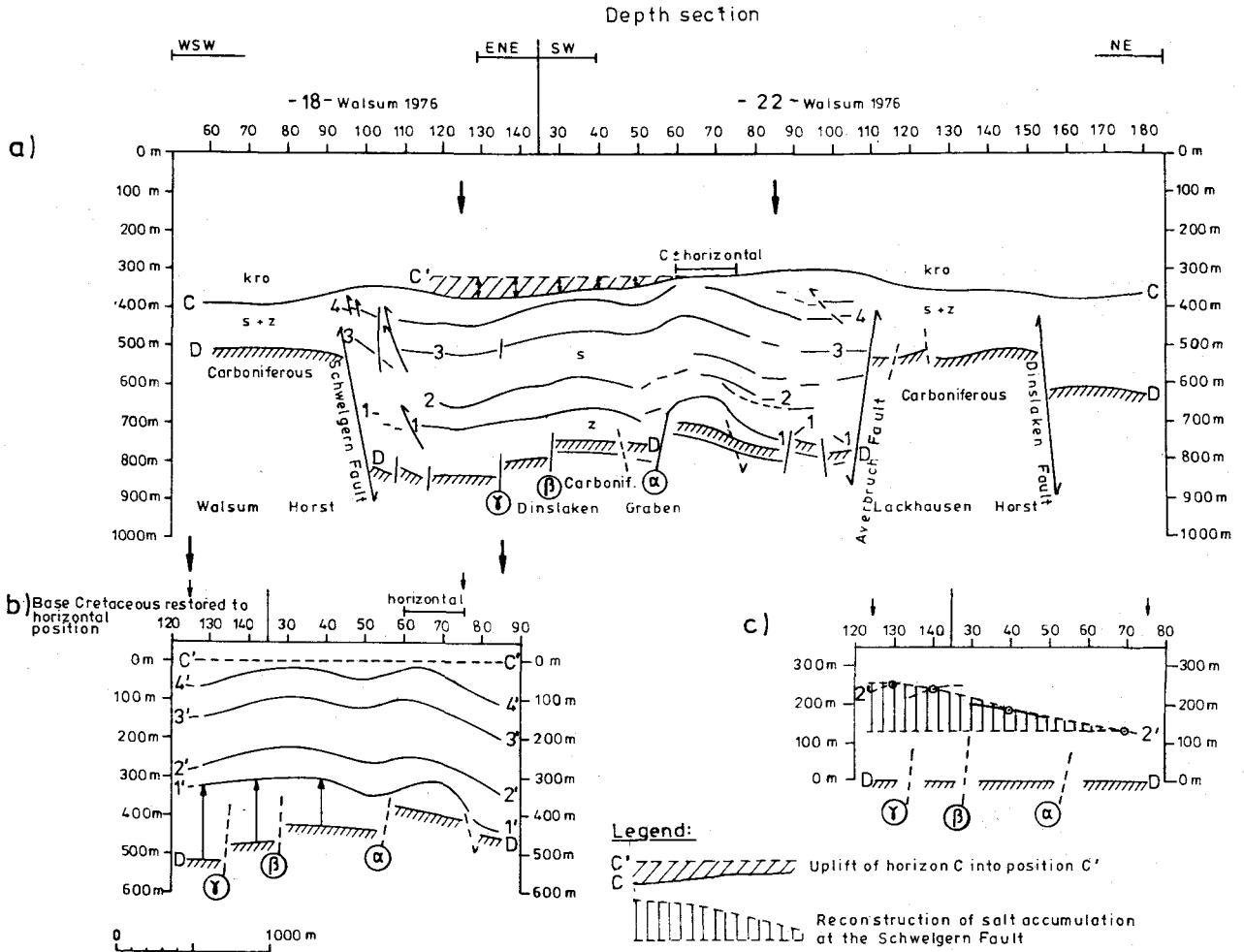

FIG. 16.- Cross-section through the Dinslaken Graben.

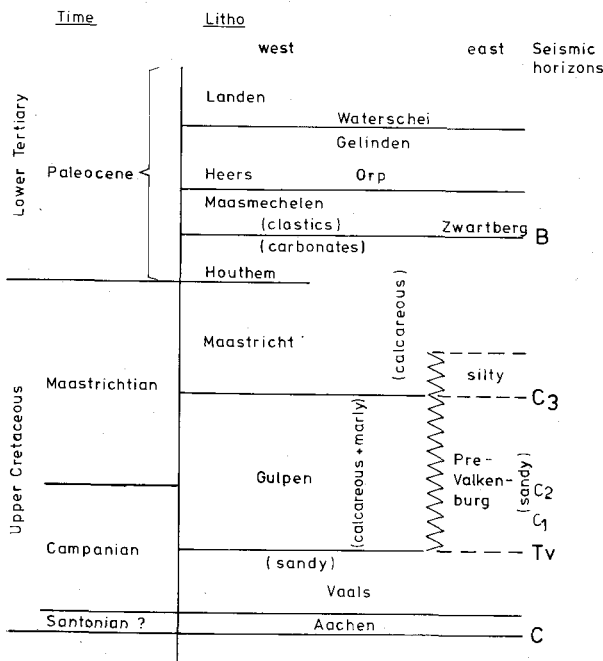

FIG. 17.- Stratigraphic table around the Cretaceous-Tertiary transition in the Campine after Felder *et al.* (1985) showing the position of seismic reflection horizons.

3.1.1.- Zechstein, Trias and Lias

These units (commonly denominated Red Beds) only occur in the northeastern Campine, north of the mining district where they wedge out below the Upper Cretaceous abrasion surface. They have been deformed in late Kimmerian times associated with the uplift of the Brabant Massif and subsidence of the Rur Valley Graben (fig. 18) as suggested by Legrand (1961).

At the graben edge major downthrow occurs along the Heerlerheide and Feldbiss (9) faults. At present Muschelkalk has only been recognized in borehole 64, and Keuper and Lias in borehole 99, both already within the Rur Valley Graben (fig. 18) (Delmer, 1963).

(9) The exact relationship between the Feldbiss and the Geleen fault located further to the southeast in the South-Limburg area is yet unclear. For historical reasons the name Feldbiss is still retained (Paulissen, 1973; Paulissen, Vandenberghe & Gullentops, 1985).

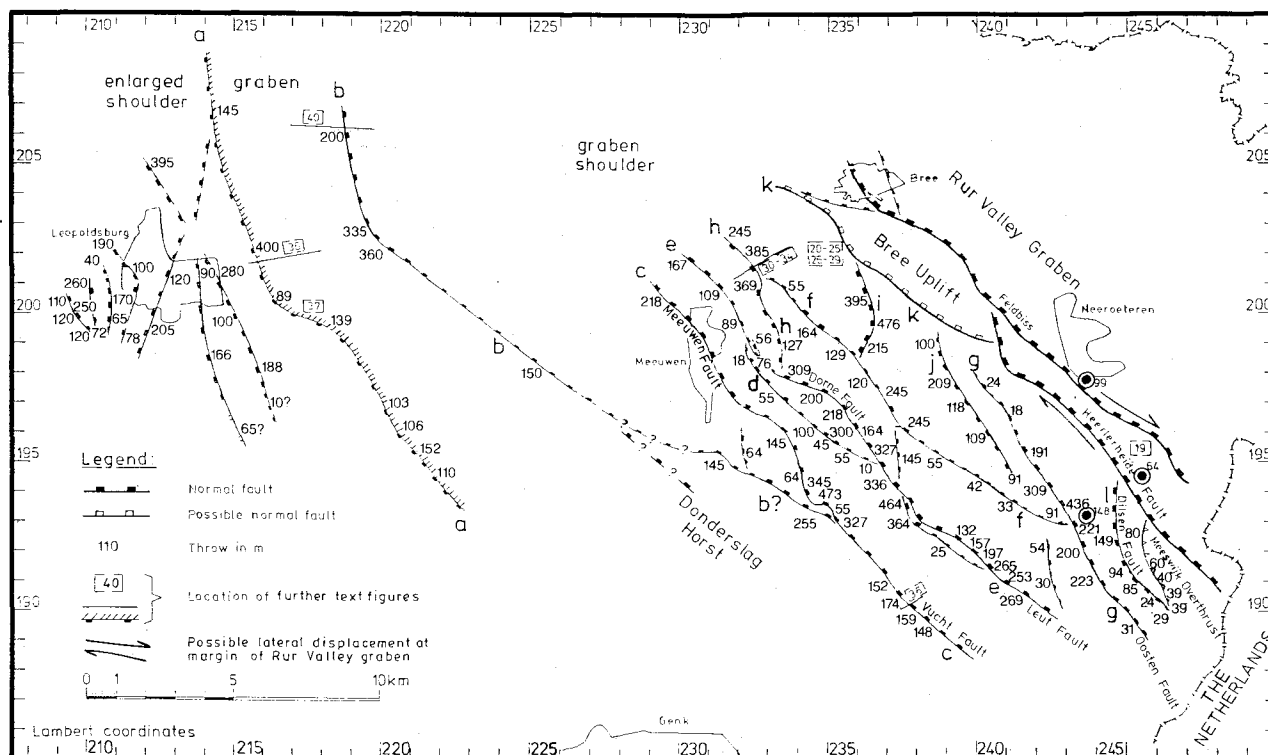

FIG. 18.- Main faults in the Carboniferous of the coal exploration area in the northeastern Campine.

3.1.2.- Cretaceous

The Campine Cretaceous consists of Santonian (?), Campanian and Maastrichtian sequences which are younger than the Niederrhein Cretaceous sequences. The inversion movements can be followed in the Late Cretaceous and even in the overlying Tertiary sequence. The stratigraphical relationships in the Campine Cretaceous have been elucidated by Felder *et al.*, (1985) who also provided insight in the paleogeographical and lithofacies changes due to the inversion. It is emphasized that on seismic sections only lithostratigraphic markers are recognized. Especially in the Cretaceous-Tertiary transition these do not coincide with chronostratigraphic boundaries (fig. 17). The chronostratigraphic boundary between Tertiary and Cretaceous occurs within a rather homogeneous calcareous sequence (Maastricht and Houthem Formations). The seismically recognizable base of the clastic Tertiary coincides with the base of the Orp Sand in the western Campine resp. the Zwartberg Clay in the eastern Campine.

The chronostratigraphic boundary between Maastrichtian and Campanian occurs within the Gulpen or Pre-Valkenburg formation and not at the base of the Maastricht Formation. These inconveniences cannot be avoided when using seismic sections. In the western part of the surveyed area (campaign Leopoldsburg 1984, fig. 18) the transition between the basal sandy Vaals Forma-

tion and the overlying calcareous Gulpen Formation builds a high-frequency reflection (reflection TV, top Vaals). In the eastern part of the Campine the sandy facies remains predominant in the Pre-Valkenburg beds equivalent to the Gulpen Formation. Seismic separation between Vaals and Pre-Valkenburg is very weak. However in the vicinity of the Bree Uplift (see section 3.2.), three reflections (TV, C₁, C₂) can be recognized in the Vaals—Pre-Valkenburg sequence.

It is assumed that inversion movements started during the early Upper Cretaceous that is not preserved in the Campine. For this period the inversion can be described as uplift and subsequent erosion of the originally downthrown block. When during inversion sediments were deposited on both sides of the fault, the inversion can be described as the subsidence difference between the adjoining fault blocks: the originally upthrown block was warped more than the originally downthrown block. However it is not yet proved that the inversion was already active during the erosive or non-depositional period of the Upper Cretaceous. A more pronounced inversion in the Carboniferous rocks (or inverse bending as in fig. 8c) than in the overburden would support this suggestion.

3.1.3.- Tertiary

The Tertiary is characterized by an alternation of sand and clay units, occasionally calcareous.

This allows a fine seismic subdivision studied in detail in a forthcoming Ph-D thesis by R. Demyttenaere (KUL). For this study Tertiary reflections are mostly used for fault analysis.

In the Campine the Late Paleocene and Eocene beds are gradually truncated by the Oligocene transgression from west to east. Otherwise Upper Cretaceous and Tertiary beds remain concordant. The basal Oligocene unconformity is only marked on long east-west striking profile lines.

3.2.- FAULTS IN THE CARBONIFEROUS

Figure 18 covers the recent coal exploration area north of the Campine collieries, between Leopoldsburg in the west and the Rur Valley Graben in the east (10). In the middle part of this area («Donderslag Horst», cf. Tys, 1980) seismic data are still lacking. The main faults observed in the Carboniferous are shown with throws as measured from crosspoints of seismic sections. They are located with respect to the seismic markers utilized for interpretation in the Carboniferous. East of the Donderslag Horst most major faults are downthrown to the east. They descend stepwise to the Rur Valley Graben, that is bounded by the Heerleheide and Feldbiss faults.

In this area some faults with opposite direction - h, i, j and l (fig. 18) - divergate from the Rur Valley Graben boundary and wedge in the main faults thus forming small grabens widening towards the north. This fault pattern may indicate a dextral strike slip movement of the graben towards the south (see arrows on fig. 18). Faults h and i (fig. 39) were active in Asturian and Late Kimmerian times. Fault 1 (= Dilsen fault, fig. 35) was active during the deposition of the Pre-Valkenburg Formation (Campanian-Maastrichtian transition).

The area between the Heerleheide Fault or Bree Uplift and the Donderslag Horst is further defined as *graben shoulder*. West of the Donderslag Horst the throw direction is more random. This area including the Donderslag Horst is further defined as *extended graben shoulder*. The vertical displacement of the top Carboniferous is strongest at the Rur Valley Graben fault margin. Minimal values for the Late Kimmerian displacement are discussed in chapter 3.4.1. and in figure 19. The Carboniferous throw within the graben margin is as yet unknown.

Inversions at the margin of the Rur Valley Graben have been described by Patijn (1961) from the Maurits coal-mine area in South-Limburg. The throw values on figure 18 are expressed in meters. These are derived from seismic sections and may need corrections. Nevertheless they are representative for the importance of the fault values.

3.3.- THE UPPER CRETACEOUS-TERTIARY INVERSION IN THE CAMPINE AS DEDUCED FROM SEISMIC DATA

Prior to the recent coal exploration surveys inversion tectonics were not recognised in the Campine except for the Cretaceous thickness reduction in the Rur Valley Graben (Legrand, 1961). This can be explained by the rather inconspicuous displacements caused by inversion in the mining area. Seismic surveys were necessary to detect inversions on the *graben shoulder* and *extended graben shoulder*. An essential feature of the inverted fault zones is a reactivation by normal faulting or warping during the Tertiary. These movements generally are in balance which means that the base Cretaceous is found at similar levels on both sides of the fault zone (see 3.5.2. and figs. 30-34). This explains why the inversion could not be detected in the Campine by the drilling campaigns.

The results of the seismic investigations are presented here in the form of vertically exaggerated sections and maps. Diagrams showing the vertical fault movements at the Cretaceous-Tertiary transition in relation with time are based on the Elsevier stratigraphic table (1978 edition). Since the seismic reflections depend on lithostratigraphic boundaries for which the exact time is not necessarily known (see part 3.1.2. and fig. 17), the diagrams rather give indications of the relative movements.

3.4.- MOVEMENTS AT THE MARGIN OF THE RUR VALLEY GRABEN

3.4.1.- The margin of the Rur Valley Graben south-east of the Bree Uplift

Figure 19c shows a cross-section based on wells through the western marginal faults (Heerleheide and Feldbiss) of the Rur Valley Graben. In the seismic survey Neeroeteren-Rotem 1980, only time sections were interpreted; for this reason lithostratigraphic intervals are measured in travel time.

The velocities used were :

Tertiary : 1890 m/s (measured in well 121),

Cretaceous : 2770 m/s (averaged from wells 121 and 147 = K.S. 6),

Jurassic and Triassic : 2990 m/s (measured for Triassic in well 121), and

Carboniferous : 3636 m/s (measured in well 146).

(10) Fig. 18 also shows the position of figs. 19 to 40, with the exception of figs. 35 and 39 which cover the same area as fig. 18.

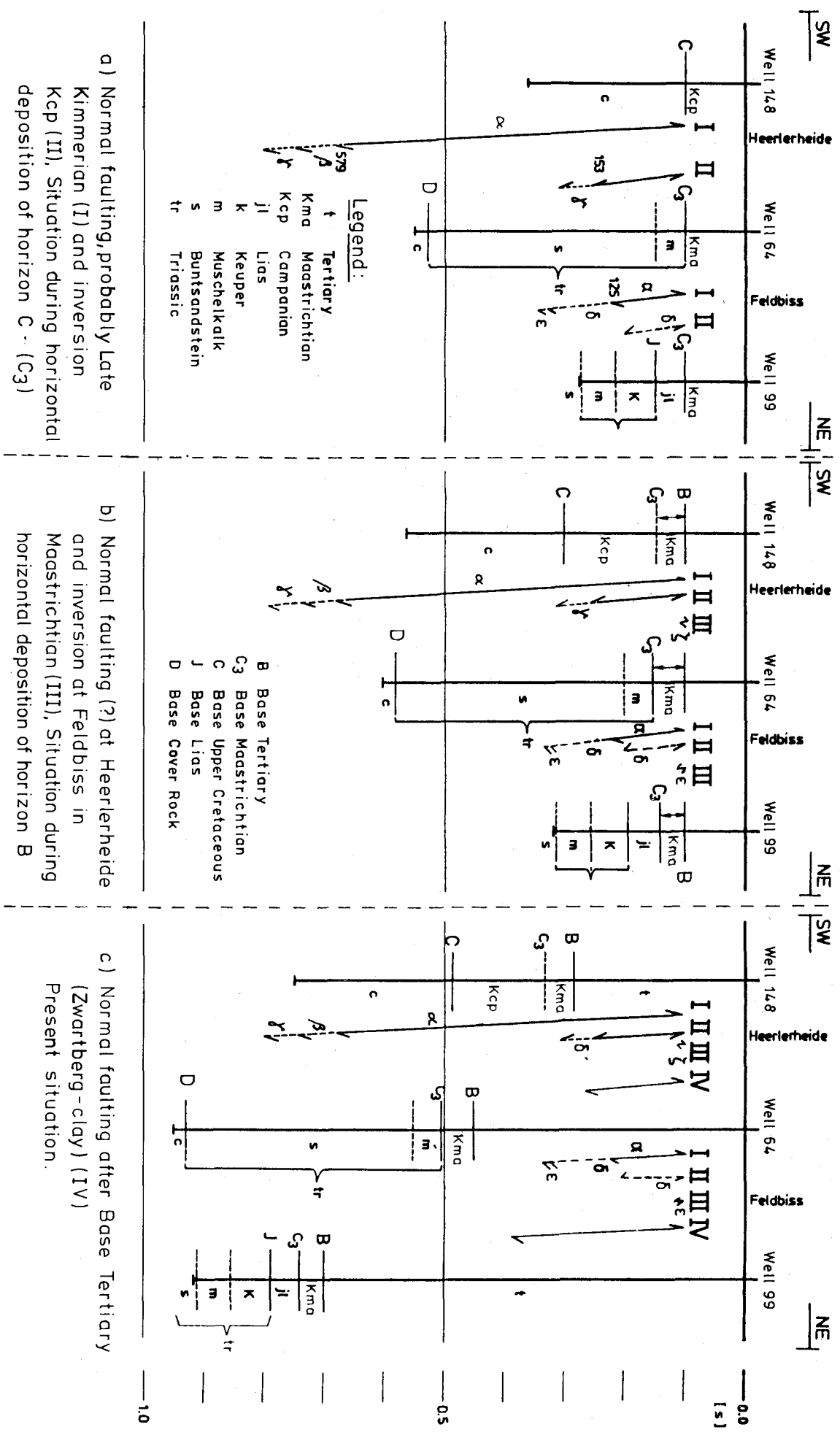

a) Normal faulting, probably Late Kimmerian (I) and inversion Kcp (II), Situation during horizontal deposition of horizon C - (C3)

b) Normal faulting (?) at Heerlerheide and inversion at Feldbiss in Maastrichtian (III), Situation during horizontal deposition of horizon B

c) Normal faulting after Base Tertiary (Zwartberg-clay) (IV) Present situation.

FIG. 19.- Idealised cross-section through the Heerlerheide and Feldbiss Faults. No horizontal scale - the adjacent blocks are simply placed next to one another as horizontal bedding exists. Seismic travelttime from sea level.

Wells 148 and 64 are located on seismic line 8010 of the Neeroeteren-Rotem 1980 survey, however, at different distances from the Heerlerheide Fault (fig. 18). Nevertheless, as the overburden sequences are approximately horizontal and no disturbances occur between the wells and the faults this shortened presentation is none the less representative. Well 99 to the east of the Feldbiss is located on line 8005 of the same survey. Again the simplified presentation in an idealized cross-section is admissible for elucidating the current problem.

Figures 19a and 19b show the same idealized cross-section over the Heerlerheide Fault and Feldbiss as figure 19c. However, they depict earlier geological times. In figure 19a the base Campanian (horizon C) and the base Maastrichtian (horizon C3) lie at the same level on either side of the Heerlerheide Fault. In figure 19b the base Tertiary was set at the same level on both sides of the faults.

The roman numbers in figure 19 refer to the periods of movement at the faults :

- I = Late Kimmerian normal faulting
- II = inversion during Campanian
- III = movement during Maastrichtian
- IV = normal faulting after deposition of base Tertiary.

The amount of displacement at the faults is marked by Greek letters.

The Late Kimmerian displacement (I) at the Heerlerheide Fault is calculated from the following components (11) :

- 1) Triassic thickness in well 64,
- 2) + Campanian thickness in well 148 (movement II) = measurable minimum movement α ,
- 3) + unknown amount of erosion on the uplifted block prior to Campanian = β ,
- 4) + unknown amount of inversion during older Upper Cretaceous above Campanian thickness of well 148 = γ .

The Late Kimmerian displacement (I) at the Feldbiss is made up of the following components :

- 1) measurable displacement of the base Muschelkalk = α ,
- 2) + unknown amount of inversion during Upper Cretaceous (not only during Campanian) prior to base Maastrichtian = δ ,
- 3) + measurable inversion movement during Maastricht = III, amount ϵ (fig. 19b).

As older Upper Cretaceous and Campanian are presumably missing on either side of the Feldbiss, the amount of Upper Cretaceous inversion prior to deposition of the Maastrichtian (δ) cannot be precisely determined for the Felbiss. The amount for the Campanian, however, may on the one hand have been smaller than the Campanian thickness in well 148 as a result of the inversion at the Heerlerheide Fault. The amount of inversion for the Maastrichtian (ϵ , fig. 19b) (resulting from the difference in Maastrichtian thickness on either side of the fault may on the other hand

(considering the information gained from the faults on the graben shoulder) be regarded simply as weaker after-movements of a previous larger Upper Cretaceous inversion.

The Late Kimmerian normal fault (I) appears to have been larger at the Heerlerheide Fault than at the Feldbiss, although regarding the Upper Cretaceous inversion (II) prior to deposition of the Maastrichtian an exact comparison in size between the Heerlerheide Fault and Felbiss is not possible.

The latest movement (IV) - normal faulting after deposition of base Tertiary - is larger at the Feldbiss than at the Heerlerheide Fault.

Independent of the direction of movement an earlier and a later mobility can be considered at the graben margin zone. At the Heerlerheide Fault the earlier mobility was greater, during the Late Kimmerian orogeny and during the Campanian. At the Feldbiss the later mobility was greater, after deposition of the base Tertiary. Similar observations were made along these faults in the Netherlands South-Limburg coalfield (Müller, 1945).

During the Maastrichtian the movement at the Heerlerheide Fault (ζ) was a forerunner of the Tertiary normal faulting whereas at the Felbiss (ϵ) it was a recurrence of the inversion.

From this analysis of figure 19 it is clear that the Late Kimmerian normal faulting at the Heerlerheide Fault was considerably greater than at every other fault on the graben shoulder.

3.4.2.- Inversion sequence at the Bree Uplift

The northeastern boundary of the Bree Uplift, which is furthermore a gravity maximum (12), is formed by the Feldbiss (Bouckaert *et al.*, 1981). It can be assumed that the southwestern fault boundary, fault k, is a large eastward dipping normal fault for the Upper Carboniferous and above all for the Late Kimmerian movements (fig. 18). However, this has not yet been proved by seismic sections since the reflections below the Upper Cretaceous on the Bree Uplift cannot be correlated with those on the adjacent graben shoulder. Unfortunately no wells exist on the Bree Uplift. Nevertheless it is evident that fault k develops from the Heerlerheide Fault and forms its continuation.

(11) In all the considerations, which include comparisons of thickness or travelttime difference, compaction effects are ignored.

(12) The inversion structure of the Drevenack Fault in the BAG Niederrhein (see 2.5.1.) is also a gravity maximum.

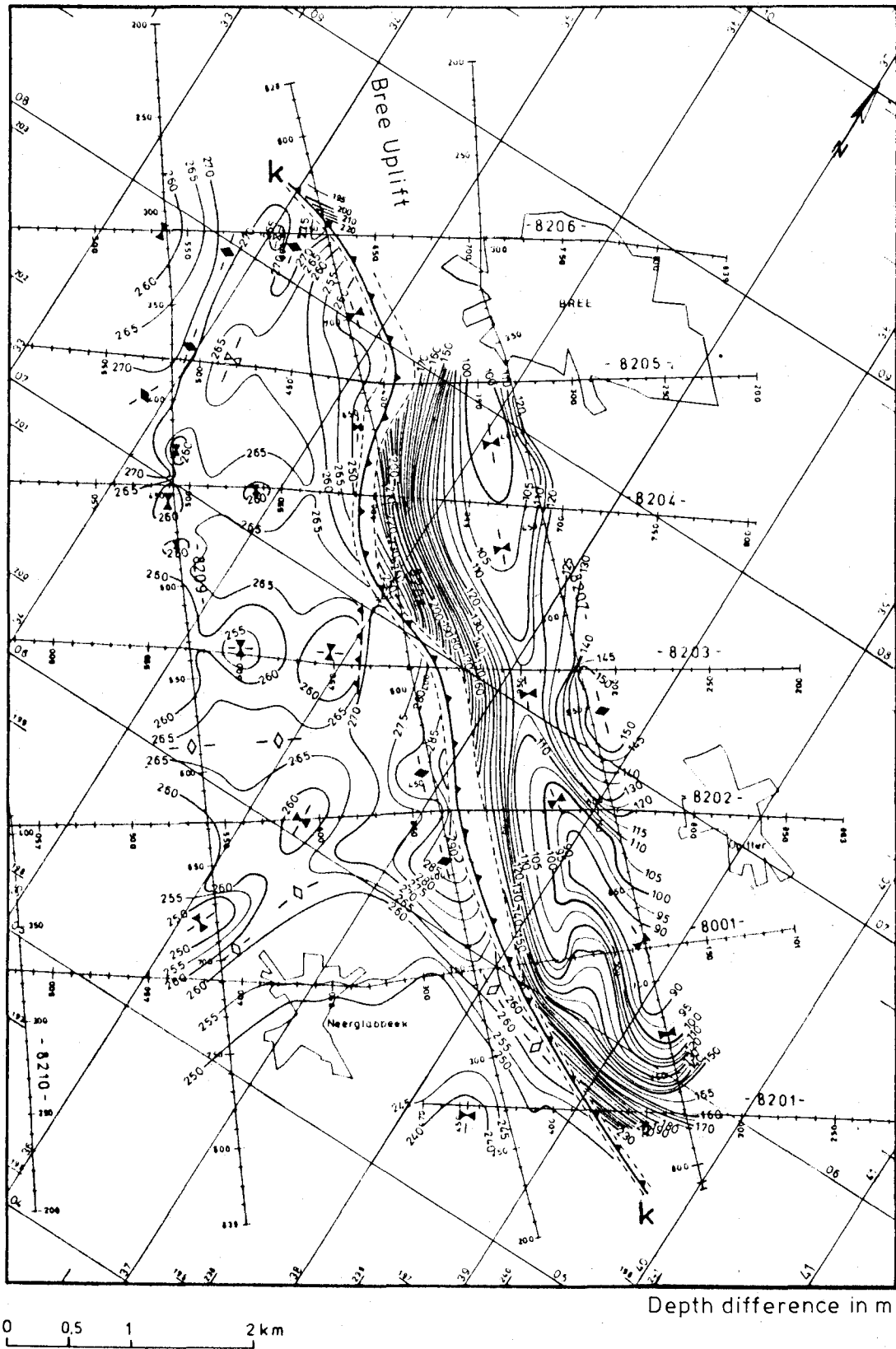

FIG. 20.- Meeuwen-Bree 1982
Depth difference map C-C₃
(Vaals and Pre-Valkenburg).

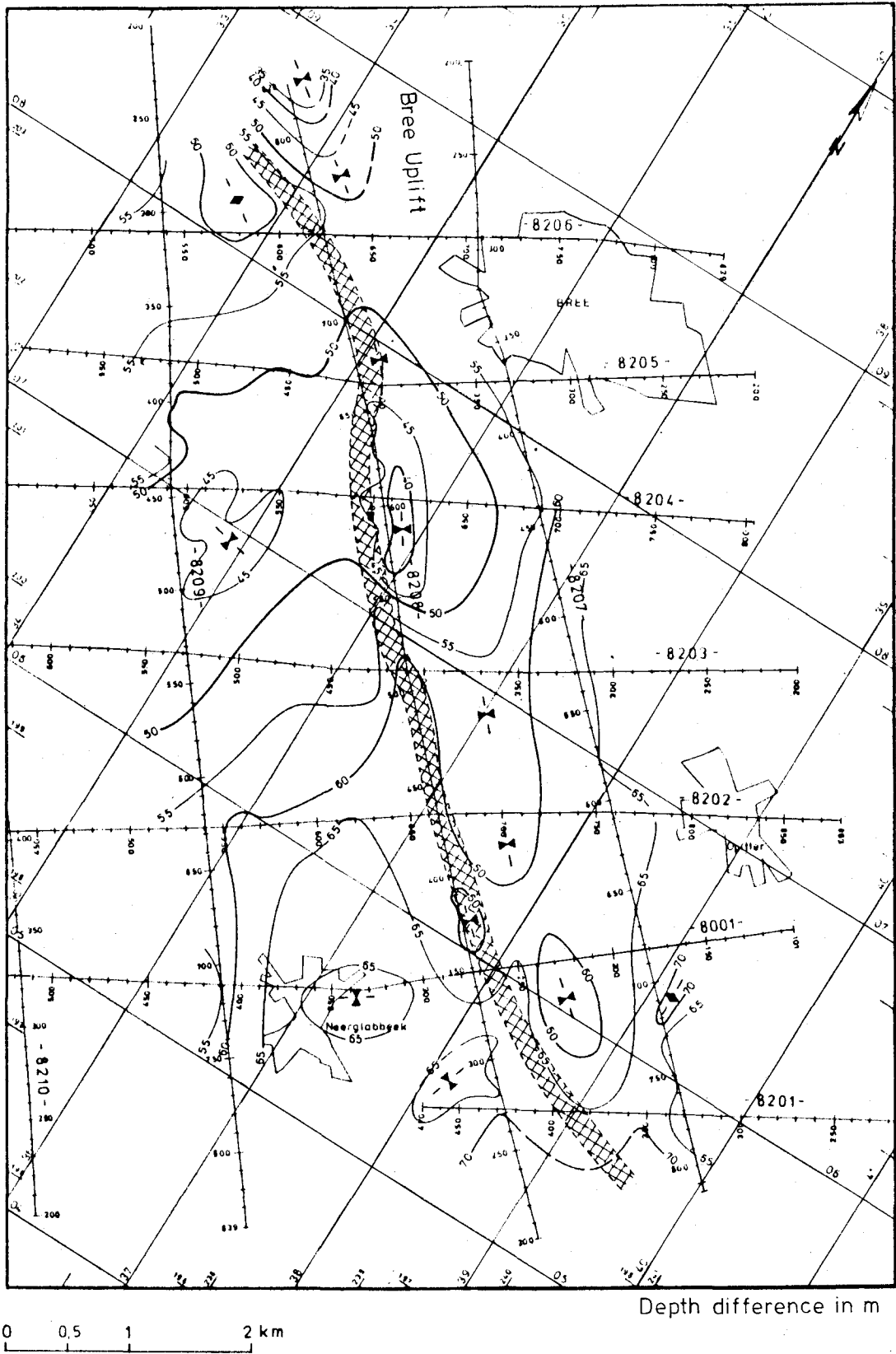

FIG. 21.- Meeuwen-Bree 1982
Depth difference map C₃-B
(Maastricht and Houthem).

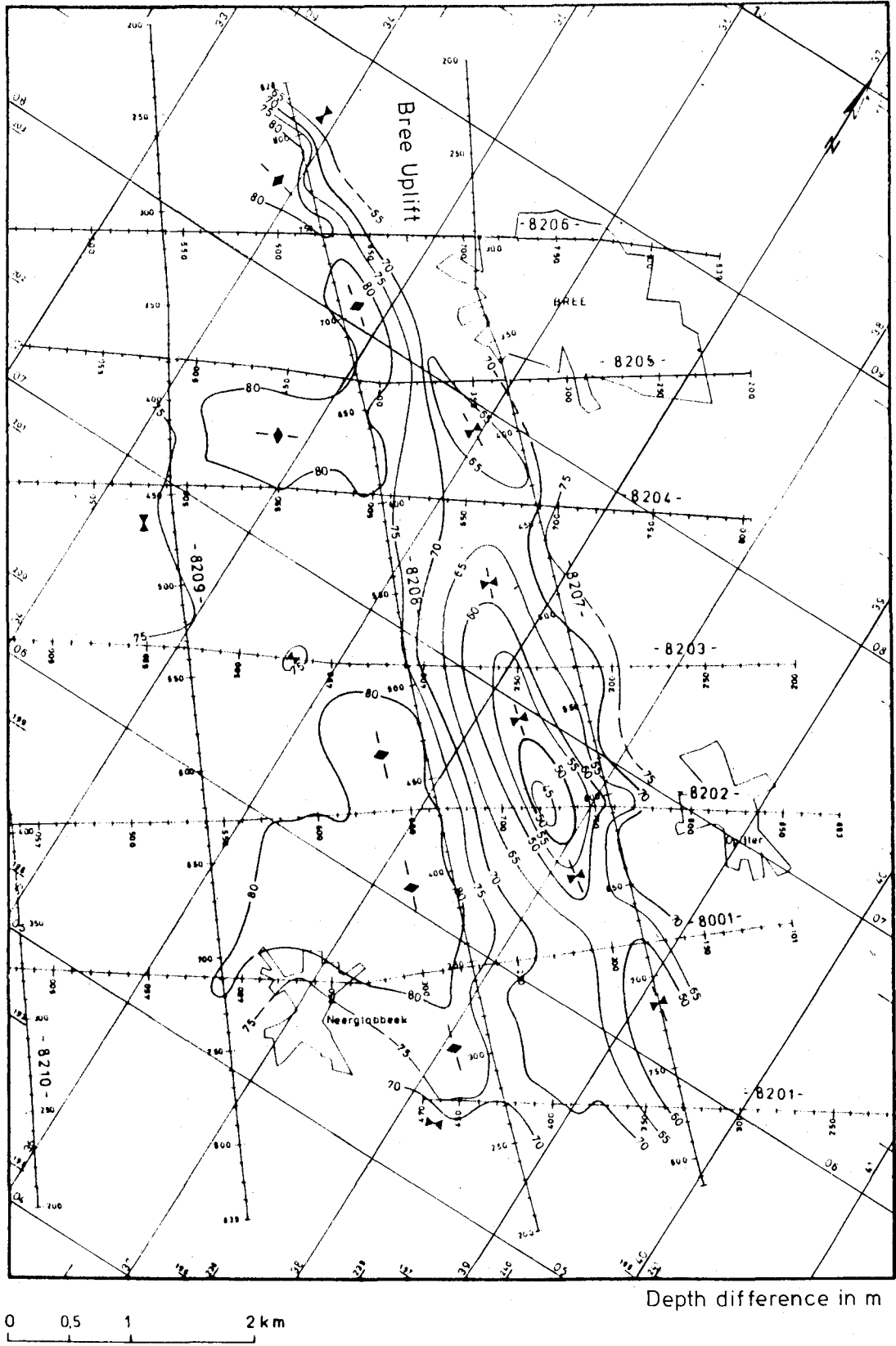

FIG. 22.- Meeuwen-Bree 1982
Depth difference map B-O
(Zwartberg, Heers and Landen).

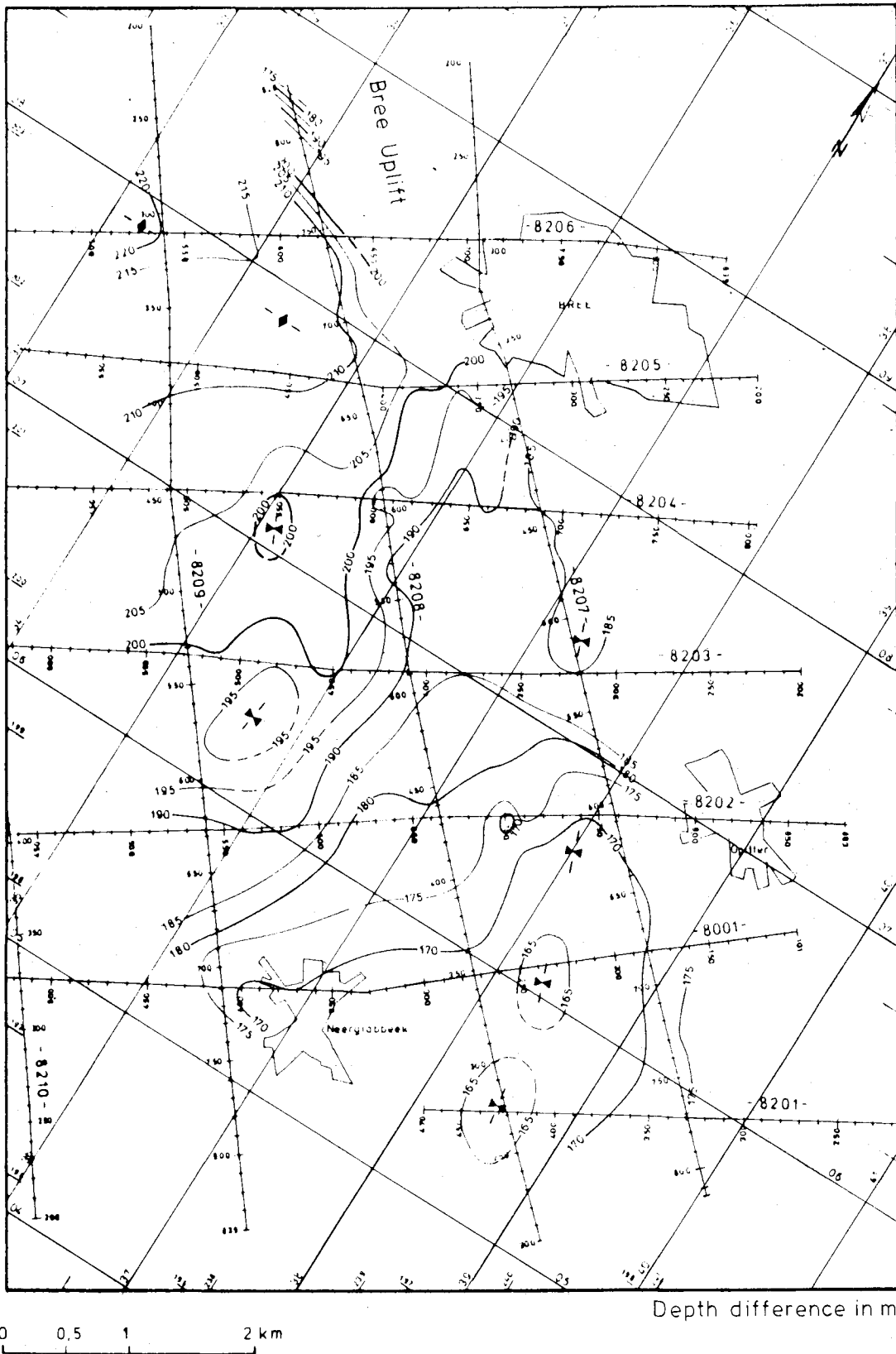

FIG. 23.- Meeuwen-Bree 1982
Depth difference map O-A
(Tongeren and Rupel).

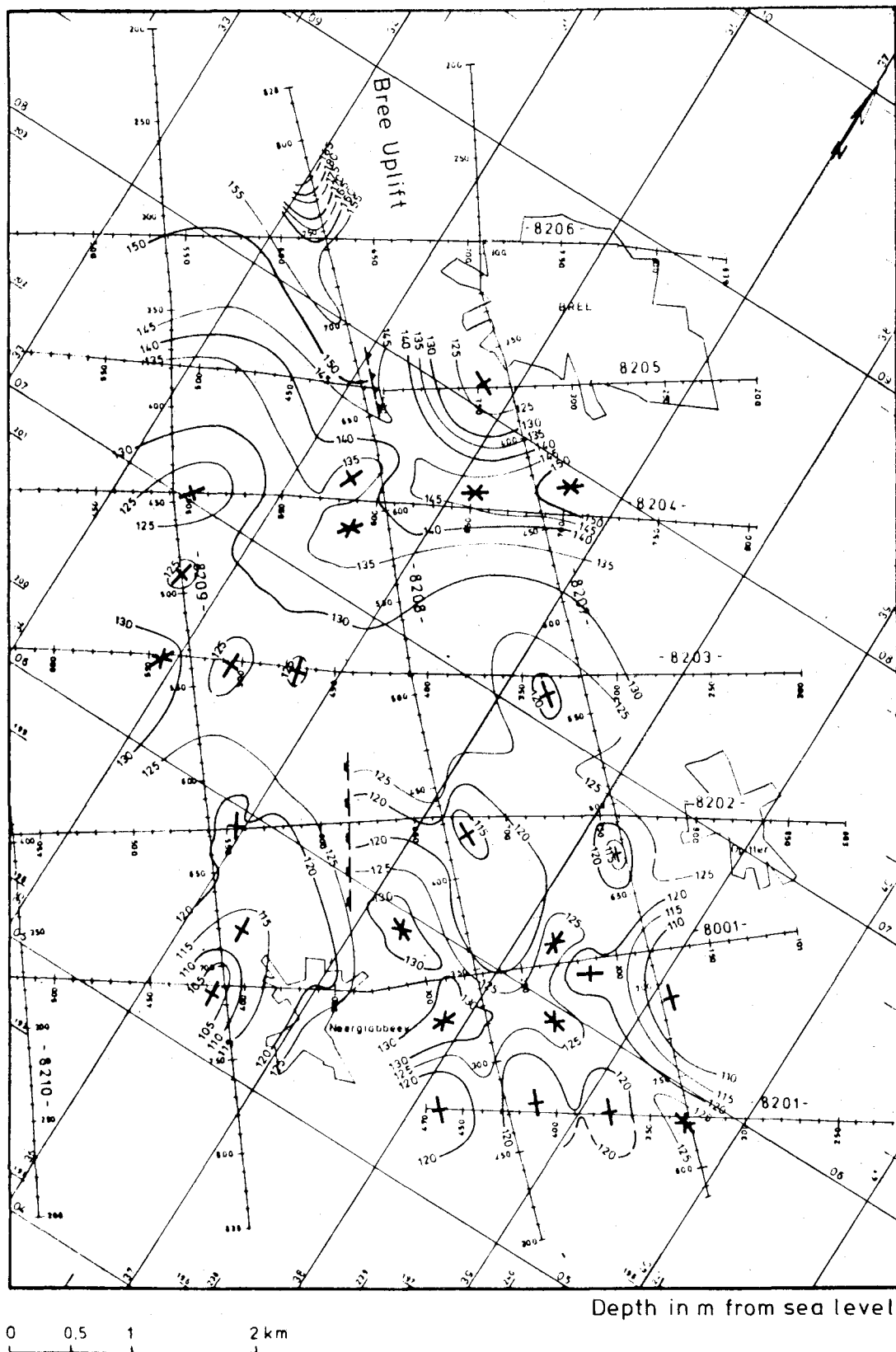

FIG. 24.- Meeuwen-Bree 1982
Depth map horizon A
(Basis Miocene).

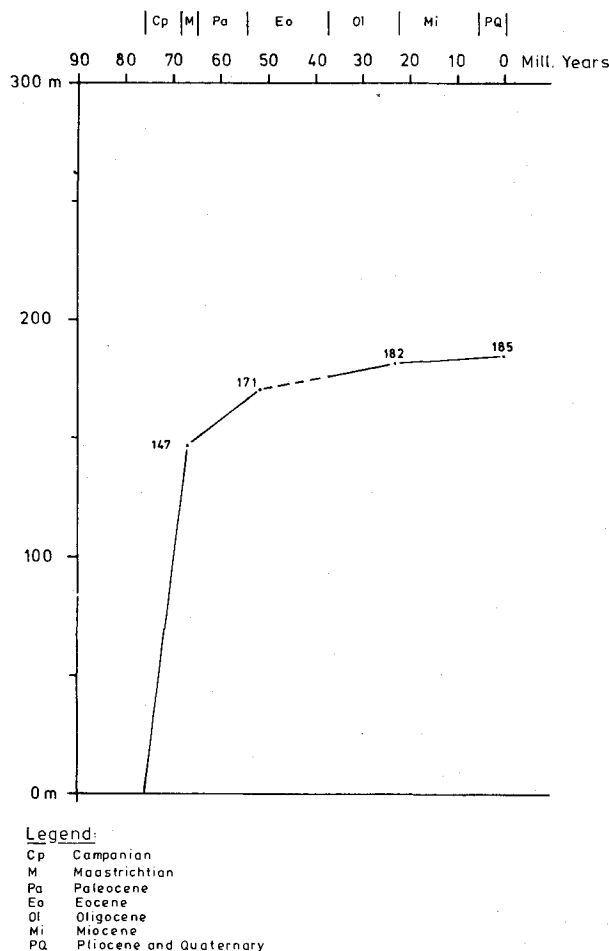

FIG. 25.- Meeuwen-Bree 1982
 Diagram showing the raising of Bree Uplift.

Figures 20 to 24 show the development of the Bree Uplift from the Campanian onwards. Figure 20 presents an isopach map of the Vaals and Pre-Valkenburg. Fault k is - assuming an eastward dip - an inverse fault. The Bree Uplift is raised considerably compared to the western foreland during the Campanian. Then during deposition of Maastricht and Houthem (fig. 21) the uplift fades out. An inverse fault is no longer present. However, the area wherein the Campanian inverse fault would reach the Maastrichtian is shown by cross hatching.

Reactivation of the Bree Uplift is evident once again during deposition of the Heers and Landen Formations (figs. 17, 22). Very local uplift occurred occasionally during deposition of Tongeren and Rupel (fig. 23) or possibly even in the Miocene (fig. 24). Figure 25 shows a diagram of the Bree Uplift as a function of geological time. Uplift values were obtained by subtraction of averaged thickness or depth values from the top line of the Bree Uplift and from another line approximately parallel to it in the western foreland (figs. 20 to 24).

It is clearly seen that the inverse uplift of the Bree Uplift has been constantly slowing down since the deposition of Vaals and Pre-Valkenburg. The relative raising of the Bree Uplift since the Miocene can only be observed locally.

Time-dependent diagrams showing the difference between the lowest and highest points of every seismic line crossing the Bree Uplift would indicate different amounts of uplift or subsidence for the various formations. Consequently more irregular diagrams would arise. The smooth movement shown in figure 25 is a result of averaging.

3.5.- MOVEMENTS ON THE GRABEN SHOULDER

3.5.1.- Graben shoulder close to the Bree Uplift

Figures 26 to 29 show the area covered by the Meeuwen-Bree 1982 seismic surveys. The profile lines cross the Bree Uplift and the adjoining graben shoulder to the west. The amount of normal faulting or inversion was calculated for the intersections of seismic profile-lines with the faults (figs. 26-29) (13).

In figures 26 to 28, the amount of displacement is given in meters, in figure 29 in milliseconds (seismic traveltime). The amount of inversion displacements is indicated in circles on the original upthrown block, whilst normal fault displacements are marked in rectangles on the original downthrown block of the Late Kimmerian fault. In addition the amount of displacement is indicated by symbols as well.

Figure 26 shows the amount of movement during deposition of Vaals and Pre-Valkenburg at the faults on the graben shoulder. Fault k at the western boundary of the Bree Uplift has the greatest inversion movement (cf. 3.4.2. and fig. 20). Not all faults were inverted everywhere, and even normal faulting tendencies can be seen.

Further structural development of the area (illustrated by figs 27-29) shows a gradual reduction of inversion activity and an increased tendency to normal faulting or warping, which is finally encompassing all faults. Only fault k shows an inversion in the Tertiary, and around line 8205 possibly even into the Late Tertiary (fig. 29).

Figures 26 to 29 therefore illustrate the contrast between the large fault delineating the Bree Uplift and the considerably smaller faults on the adjacent graben shoulder. The part of the

(13) Decimeter values resulting from seismic time calculations should not be regarded as more exact or realistic.

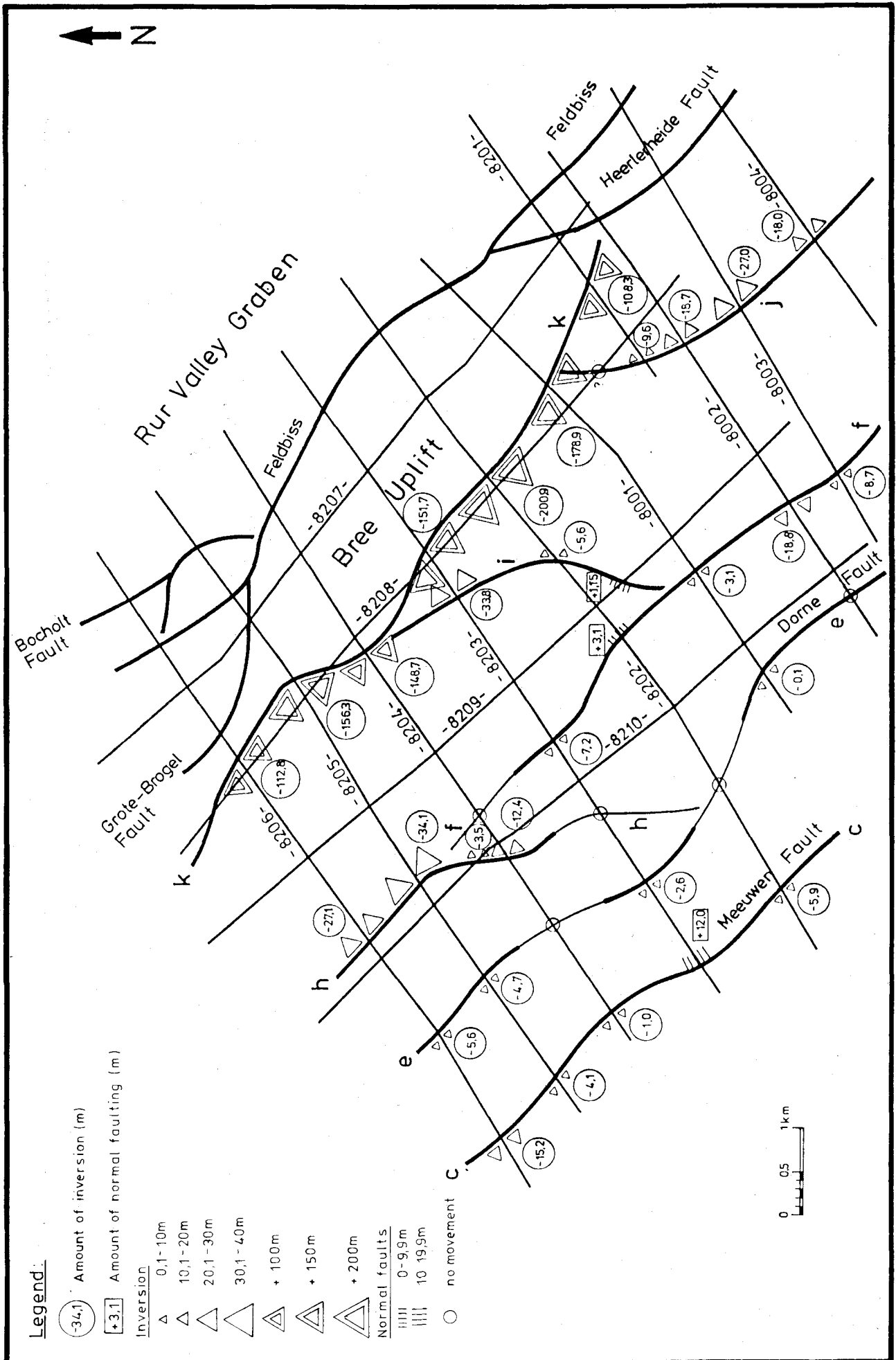

FIG. 26.-Meeuwen-Bree 1982
Amount of inversion and normal faulting during deposition of Vaals and Pre-Valkenburg, in meters.

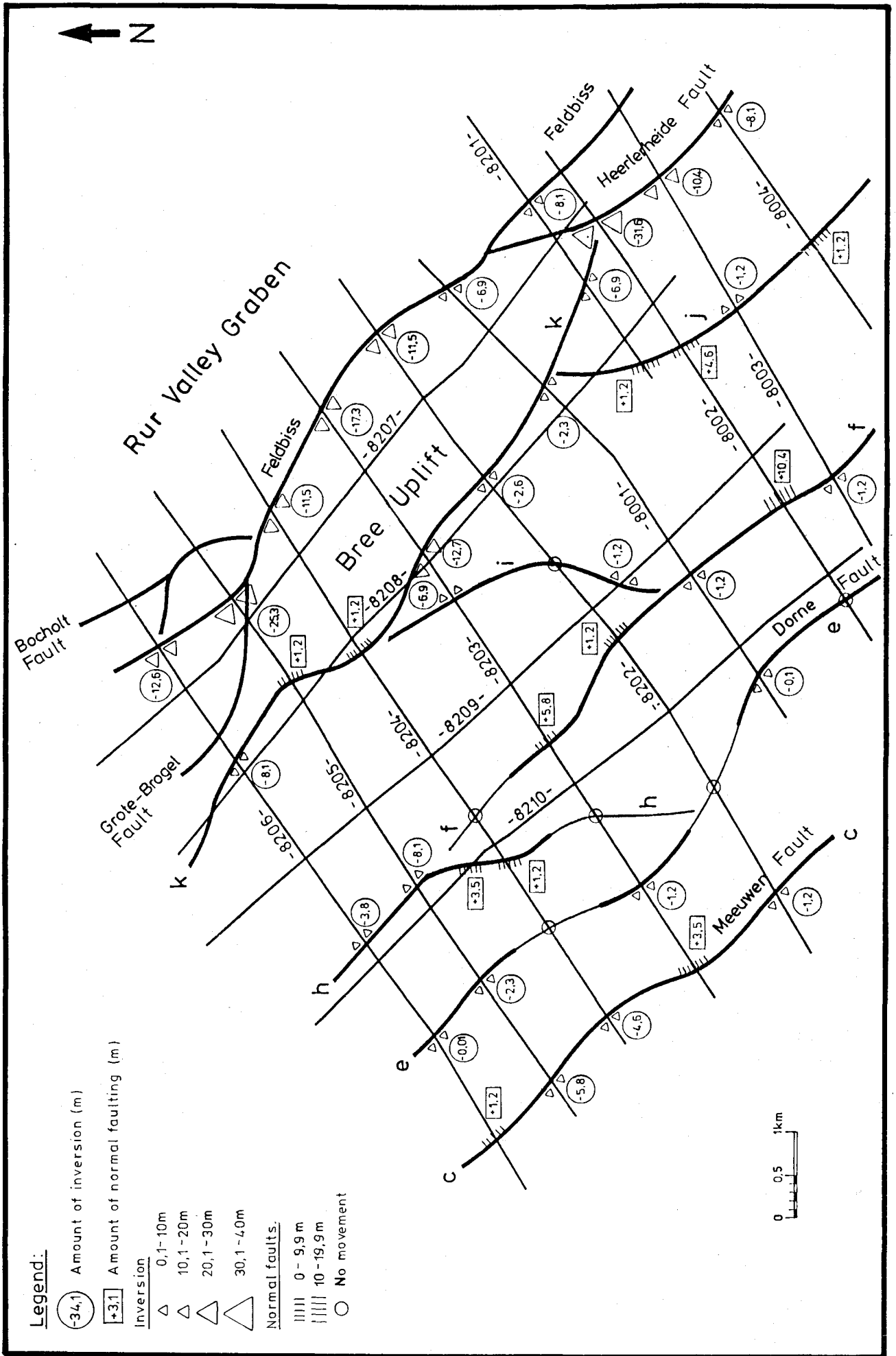

FIG. 27.- Meeuwen-Bree 1982
Amount of inversion and normal faulting during deposition of Maastricht and Houthem, in meters.

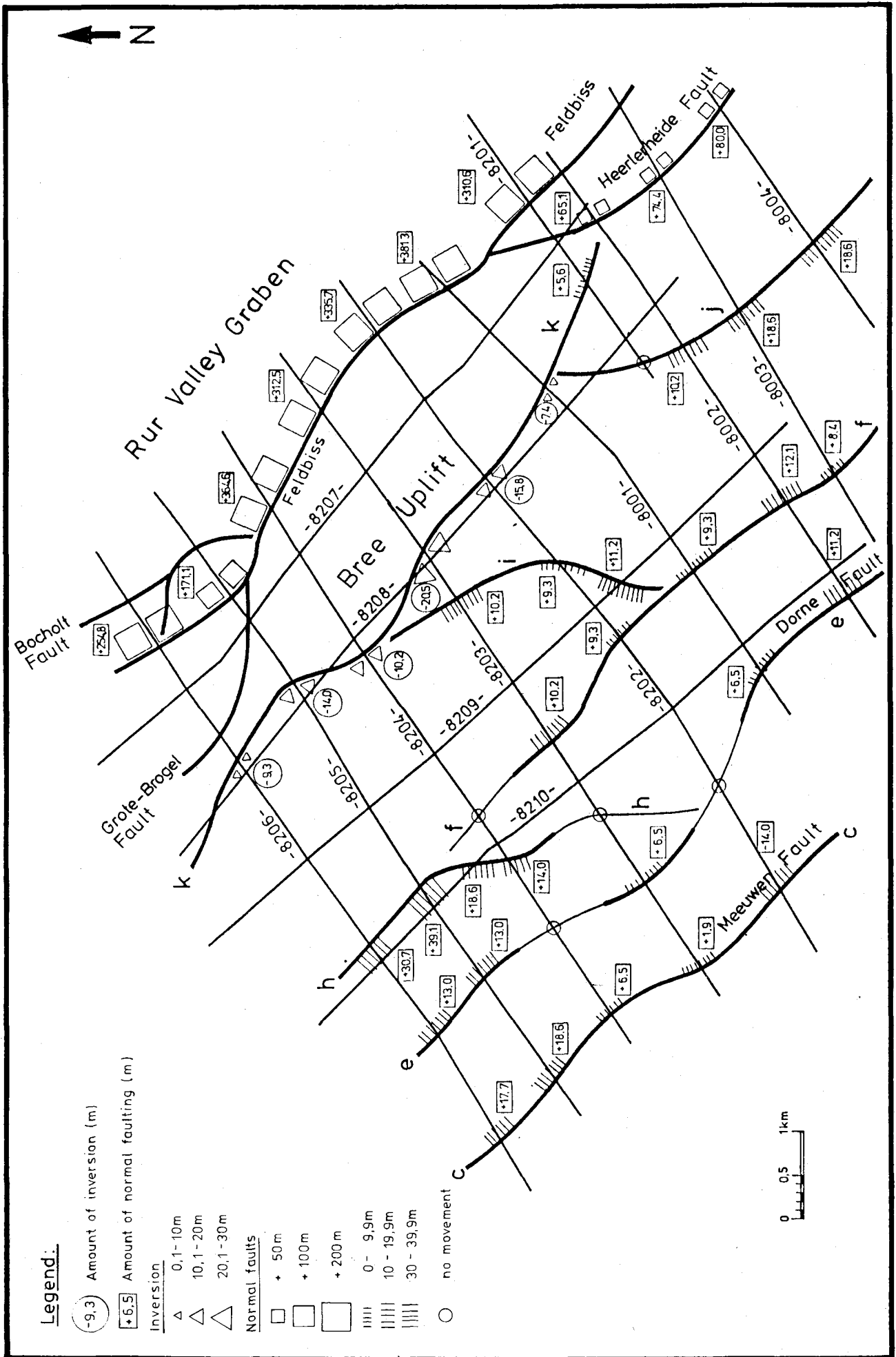

FIG. 28.- Meeuwen-Bree 1982
Amount of inversion and normal faulting of Base of clastic Tertiary (without Houthem), in meters.

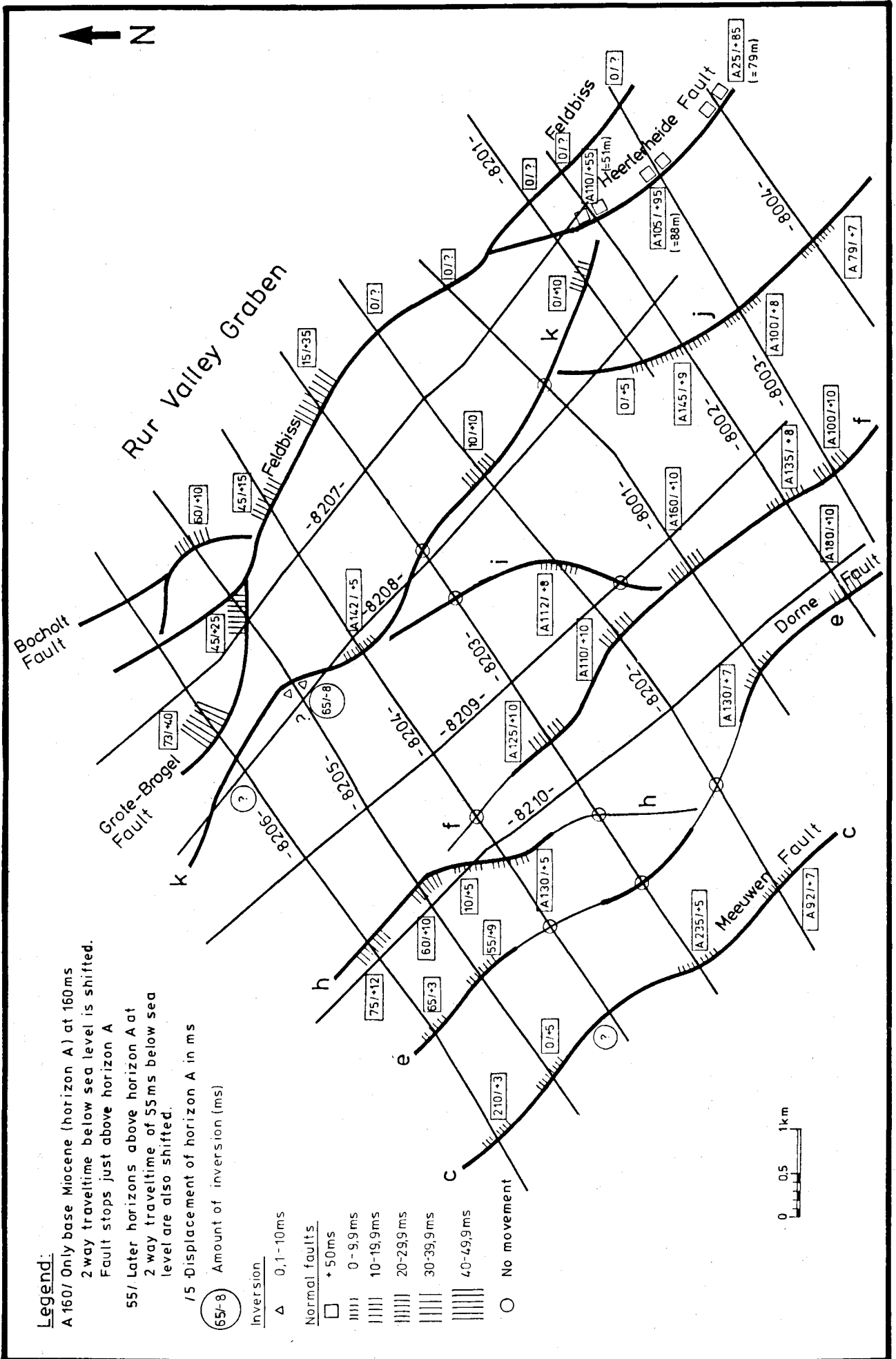

FIG. 29.- Meeuwen-Bree 1982
Amount of inversion and normal faulting at Base Miocene, in milliseconds seismic traveltime.

Heerlerheide Fault depicted on figure 27 shows a decreasing inversion towards the south-east for the Maastricht and Houthem formations. It may be remembered that farther to the south-east (between wells 148 and 64) a small normal fault probably occurred during the same period (fig. 19). The inversion persisted longest at the north-western boundary of the Bree Uplift. Whereas the inversion can still be recognized here over nearly the entire length of the fault in the Early Tertiary (fig. 28), the Feldbiss is already affected by intense and persisting normal faulting.

Inversion at the faults on the graben shoulder is likewise intense at places. However, it is considerably less than at the boundary of the Bree Uplift (fig. 26). During the deposition of the Maastricht and Houthem Formations the inversion became very weak until finally in the Tertiary a normal faulting tendency arose everywhere.

3.5.2.- Movements at fault h during the Upper Cretaceous and Tertiary

An intense inversion is conspicuous at the intersection of line 8205 and fault h during the deposition of the Vaals and Pre-Valkenburg formations (fig. 26). This inversion, as do all others in the area, fades out in the Maastricht and Houthem formations (fig. 27) and is transformed to a normal fault movement during the Tertiary (figs. 28 and 29).

Figure 30 shows the intersection of the migrated time section 8205 with fault h. A displacement of over 200 ms (more than 300 m, cf. fig 31) exists in the Carboniferous (Horizon K2). A displacement of about 20 ms exists at the base Upper Cretaceous (Horizon C). The displacement increases again in the younger beds.

Figure 31 shows the same part of the section but after depth conversion. It is surprising to see that a throw is no longer present in the base Cretaceous. However, in the shallower horizons, especially at the base clastic Tertiary (Horizon B) and in the Oligocene (Horizon O and the two horizons above) a throw is visible once again. The inversion, which was active in the Campanian as well as in the Maastrichtian, was neutralized fairly exactly (see 3.3).

Figure 32 depicts the inverse plot (see 2.7) of the Upper Cretaceous and Tertiary horizons shown in figure 31. Consequently fault h appears to dip in the opposite direction. Only Horizon C, which has not been plotted inversely, shows fault h in its correct position.

In order to get a good idea of the thickness variations on either side of the fault the depth differences between superposed horizons were

average on both sides of the fault. Depth irregularities close to the fault were ignored.

These averaged depth differences (in meters) are shown in figure 33 at an enlarged scale. If the thickness of a unit is greater to the right of the fault (i.e. on the originally upthrown block of fault h) than to the left, then an inversion existed during deposition of that unit. A greater thickness to the left of the fault (i.e. on the originally downthrown block) indicates the existence of normal faulting during deposition. Thickness differences are indicated on either side of the fault for the respective units. Addition of these differences leads again to the actual position: the resulting amount of inversion is indicated in circles on the right of the fault, whilst resulting normal faulting appears in rectangles on the left (fig. 33).

The sequence of events here is initiated by a persisting inversion which, subsequent to a weak normal faulting tendency during the Upper Paleocene, was reactivated in the Oligocene, or probably in the Eocene, reaching a maximum of 35 m. From that time to the present (at Horizon SL = C) this inversion was counter-balanced by a normal faulting tendency.

A consequence of this development is that on the graben shoulder and its western extension the base Upper Cretaceous usually does not exhibit a displacement or only a small one, whereas a throw can be easily distinguished in the overlying horizons.

Figure 34 shows the inversion and normal faulting tendencies at fault h by means of the time-dependent plot using the throws from figure 33. A strong inversion existed especially in the Vaals and Pre-Valkenburg as well as in the Maastricht and Houthem formations, whereas since the middle of the Oligocene normal faulting has prevailed. Displacement amounts to only a few meters per million years.

3.5.3.- Distribution of inversion and normal fault movements during the Cretaceous and Tertiary in the Campine

Figure 35 presents an overview of the distribution of different movements at the main faults. Inversions and normal faulting or warping are differentiated as well as short or long-lasting movements. Short, transitory movements were only active during deposition of a single formation. Periods of inversion are indicated in circles or rounded rectangles located whenever possible, on the original upthrown block of the fault. Normal faulting tendencies are shown in rectangles or squares on the original downthrown side of the fault. Fault symbols used on figure 35 are identical as on figs 26-29 (cf. 3.5.1).

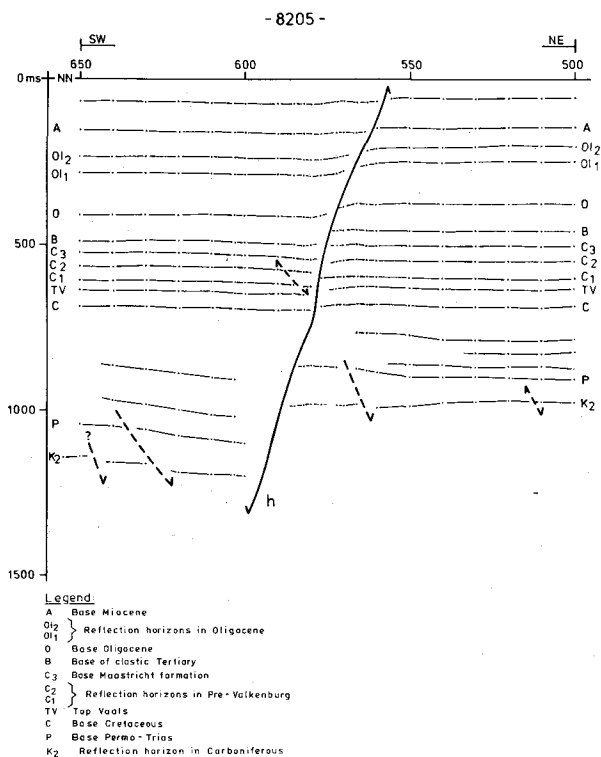

FIG. 30.- Meeuwen-Bree 1982
Seismic time section 8205. Partial view around fault h.

Sometimes it is difficult to date vertical movements because of the weakness of reflections defining formation boundaries and because of the minimal throws. Furthermore it was always necessary to avoid the area directly around the faults for comparison of time and depth differences. Transitory inversions observed in the Vaals formation are frequently associated with a marked normal faulting tendency in the Gulpen or Pre-Valkenburg formations whereas later (eg. in Maastricht and Houthem) inversion movements occur once again. These movements are small on the graben shoulder in the east, while on the extended graben shoulder in the west they are even smaller. On the graben shoulder long-lasting movements tend to become more important in the vicinity of the Rur Valley Graben. The most effective inversions initiated at the base of the Cretaceous sequence. But later starting long-lasting inversions of less importance also exist.

Movements along the length of a fault vary. Inversions and normal faulting tendencies can shift along a fault with time. It is even possible that normal faulting tendency and inversion coexist along the same fault.

3.5.4.- Movements at the western limit of the Donderslag Horst

Description of movements along fault «a» which forms the western limit of the Donderslag

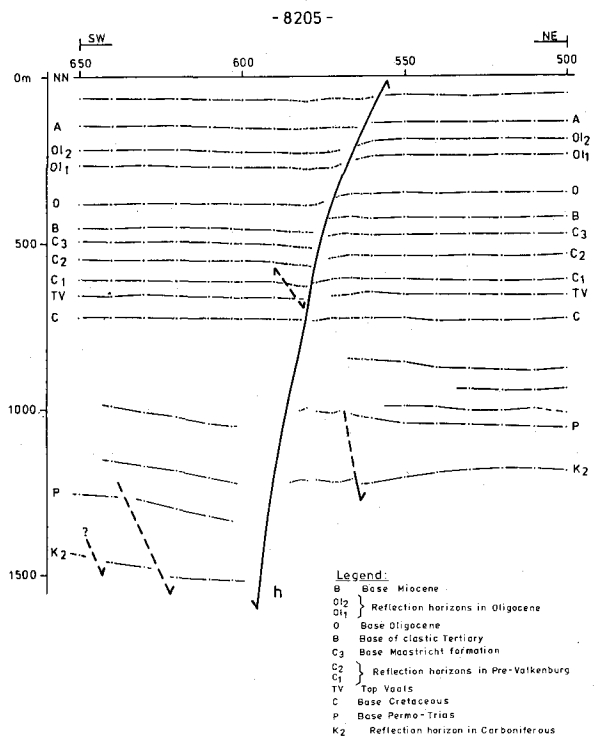

FIG. 31.- Meeuwen-Bree 1982
Seismic depth section 8205, without migration
Partial view around fault h.

Horst follows the same procedure as for the cross-section of fault h (cf. 3.5.2).

In order to determine a more accurate thickness and consequently depth difference in the inverse plot of the reflection horizons the thickness differences at eight geophone points, spread over a length of eighty geophone points, were averaged on either side of the fault zone (fig. 36b).

Because of a Late Tertiary tilting the thickness difference for the interval between base Tongeren (To) and the sea level (NN) is not representative for the displacement of Horizon C along fault a. Its movement since the deposition of the base Tongeren can be read at the base Tongeren directly, or the rate of movement should be calculated from the displacement at the base Cretaceous (not inversely plotted) and the remaining displacement at the overlying horizon To, (fig. 36b).

Diagrams showing the time-dependent plot of the vertical movements are given in figure 37 alongside the corresponding seismic lines crossing the fault. The inversion movements are clearly weaker than those at fault h (fig. 34). On all sections the observable movements at fault «a» start in the Vaals formation with inversions of varying intensity. This early inversion seems larger on the southern part of fault «a» than on the northern part.

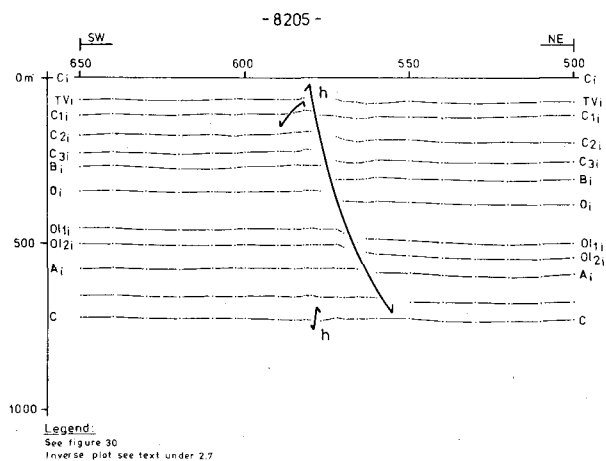

FIG. 32.- Meeuwen-Bree 1982 - Depth section 8205
Partial view around fault h. Inverse plot of seismic reflection horizons in Upper Cretaceous and Tertiary.
Fault dip in opposite direction in the inversely plotted horizons. Fault h is at its correct position only in horizon C (present depth).

All lines, with the exception of the southernmost line 8402, exhibit a normal faulting tendency in the subsequent Gulpen Formation. Only line 8404 has this normal faulting tendency persisting ever since. On all the other lines the normal faulting tendency was interrupted by a renewed longer or shorter inversion.

In the southern part normal faulting tendency prevails over inversion. As a consequence the actual position of Horizon C indicates a normal fault. On the other hand a slight inversion marks the actual position of Horizon C in the northern part.

3.5.5.- Inversion during part of the Pre-Valkenburg formation

During the time of deposition of a formation a constant difference between the originally upthrown and downthrown blocks of a fault zone does not have to prevail. An example is cited for which the Vaals and Pre-Valkenburg formations can be further subdivided.

Figure 38 shows the uninterpreted (38a) as well as the interpreted (38b) part of the migrated time section 8110 of the 1981 survey Eisdien; this section crosses the southern part of fault «c» (figs 18 and 35).

A number of weak reflections, marked 1 to 4 and 4a, are visible between the reflection horizons C and C3. The Vaals formation or at least its greater portion is contained between the reflection horizons marked C and 1. At fault C the Vaals formation does not experience an inversion but instead exhibits a normal faulting tendency (bars of different lengths between the horizons C and 1 on fig. 38b).

The reflectors 1, 2 and 3, however, moved inversely at fault c. Above the originally down-

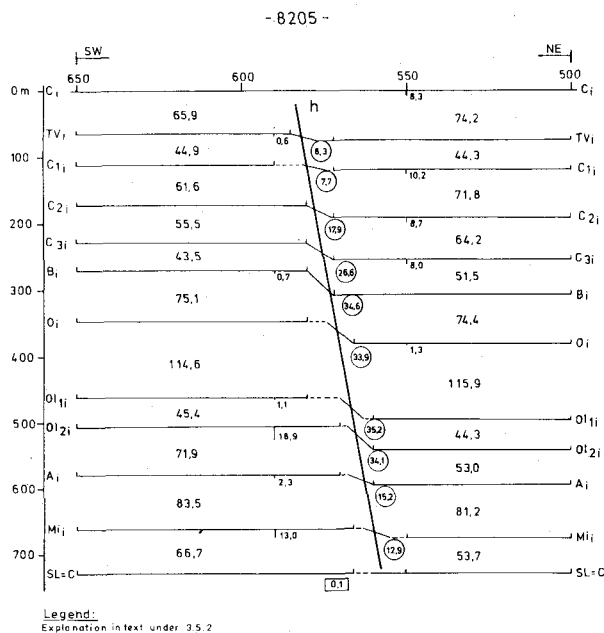

FIG. 33.- Meeuwen-Bree 1982 - Depth section 8205
Partial view around fault h. Inverse plot of seismic reflection horizons in Upper Cretaceous and Tertiary, (exaggerated 2 times in contrast to fig. 32).
The depth differences on either side of fault h are averaged.

thrown block they are found in higher position than over the originally upthrown block.

Consequently a travel-time difference, marked in figure 38b by quadrangles of different size, occurs between the reflectors 3 and 4/4a. The position of these varying travel-time differences within the C-C3 sequence indicates that an inversion occurred within just part of the Pre-Valkenburg time of deposition.

3.6.- CRETACEOUS-TERTIARY INVERSION AND LATE KIMMERIAN TECTONICS

A comparison of the Upper Cretaceous-Tertiary movements with Late Kimmerian tectonics is only possible in the area where the Lower Triassic Buntsandstein has not been affected by erosion (cf. 3.1.1. and fig. 39). The faults are located with reference to the base Buntsandstein. The Upper Cretaceous-Tertiary movements at the faults a to i shown in figure 35 can be compared with the throws in the Carboniferous and at the base Triassic (fig. 39).

Fault a : normal fault with large Asturian and even larger Late Kimmerian throws, also marked by long-lasting inversions.

Fault b : a Late Kimmerian throw is recognized on the northern part of the fault only and is insignificant compared to the Asturian throw. Movements during the Cretaceous and Tertiary are accordingly only slight.

Consequently the dashed line in figure 18 and 35 connecting both parts of fault b is questionable.

Figure 40 is a vertically exaggerated part of section 8409, which intersects fault «b» in the

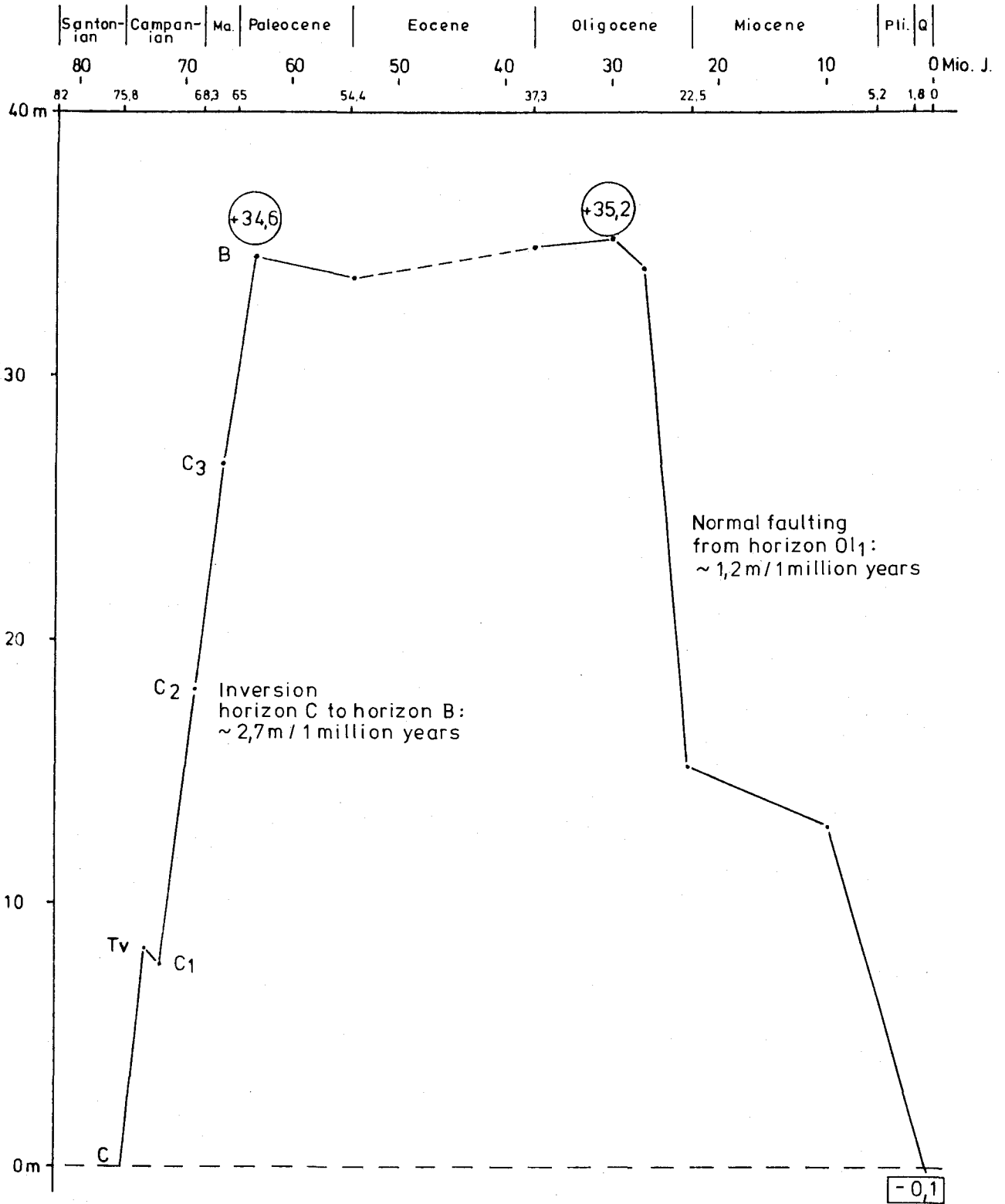

FIG. 34.- Meeuwen-Bree 1982 - Line 8205
 Diagram showing movements during Upper Cretaceous and Tertiary at fault h
 (vertical movements versus time).

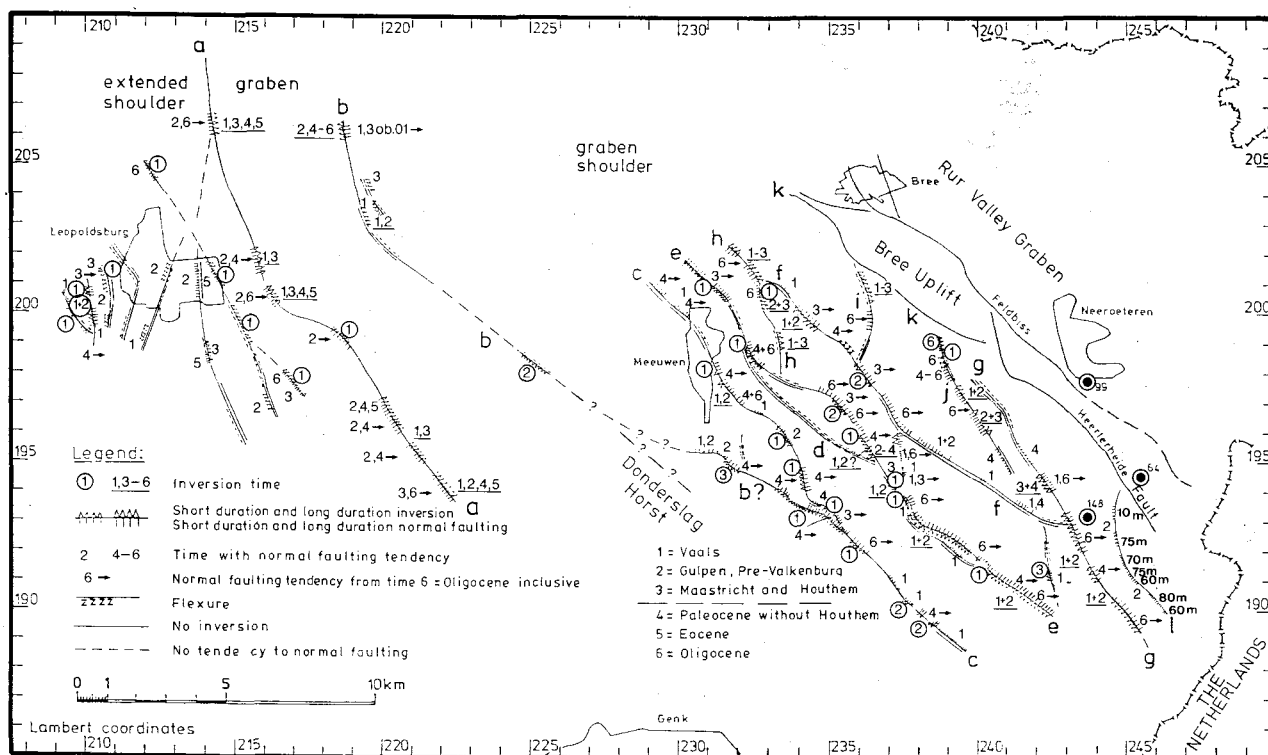

FIG. 35.- Distribution of Upper Cretaceous-Tertiary inversions and normal faulting tendency at main faults in Campine coal exploration area.

north. Fault «b» hardly displaces the base Triassic (Horizon T) and the base Upper Cretaceous (Horizon C). In higher horizons no fault can be distinguished.

The thickness distribution of the Cretaceous beds however shows that upthrown and downthrown blocks were subjected to differential subsidence in which inversions and normal faulting tendencies alternated. It is remarkable that a distinct inversion still occurred in the «Lower» Oligocene (Tongeren equivalent) immediately replaced by a normal tendency in Oligocene times. The tectonic structure depicted in figure 40 appears to confirm the idea that the local equivalent of the Tongeren formation belongs to the Eocene and is prior to the Oligocene transgression.

These movements remained small and eventually neutralized each other. Fracturation of the pre-Cretaceous rocks might be due to these cakewalk movements caused by differential subsidence.

The objection could be raised that the small thickness differences shown in figure 40 rather represent facies differences which were transformed into thickness differences by depth conversion using uniform velocities. If this might be true these facies differences are linked everywhere to the presence of fault zones.

Fault c : the fault has hardly an Asturian throw, however, the

Late Kimmerian throw is significant. An earlier inversion (Vaals, locally Pre-Valkenburg) exists but is completely lacking in the north. The subsequent normal faulting tendencies are mostly of duration. There is a strong dependence on Late Kimmerian tectonics.

Fault d : Asturian throw of this fault varies between 10 and 100 m; no Late Kimmerian movement is recognized. Also there are no inversions or normal faulting tendencies.

Fault e : Asturian throws are greater than Late Kimmerian ones. The inversion is restricted to the Vaals - locally also pre-Valkenburg formations. Subsequent faulting is late but of long duration.

Fault f : the Late Kimmerian throws are generally smaller than the Asturian ones; the amount of throw decreases to the north. An inversion is missing on the southern part of the fault but early normal faulting tendencies occur. Early inversion occurs in the north where normal faulting tendencies are usually late long-lasting movements.

Fault h : a limited Asturian normal faulting tendency exists on the southern part of the fault; in the north it seems to be missing. Late Kimmerian throws increase over a short distance from less than 50 m in the south to over 250 m in the north. The inversion extends from the Vaals to the Houthem formation but is neutralized by late long-lasting normal faulting (cf. 3.5.2 and figs. 30-34).

Fault i : the Asturian throws are larger than the Late Kimmerian ones; both increase from south to north. An inversion from the Vaals to the Houthem formation can be observed only in the north close to the Bree Uplift. In the south the fault bends to a SW-NE direction, and here neither inversion nor normal faulting tendencies can be seen. Normal faulting tendencies are completely missing along the fault or can be observed from the Oligocene onwards.

These comparisons show that Asturian faults - unless these were reactivated by Late Kimmerian

- 8407 -

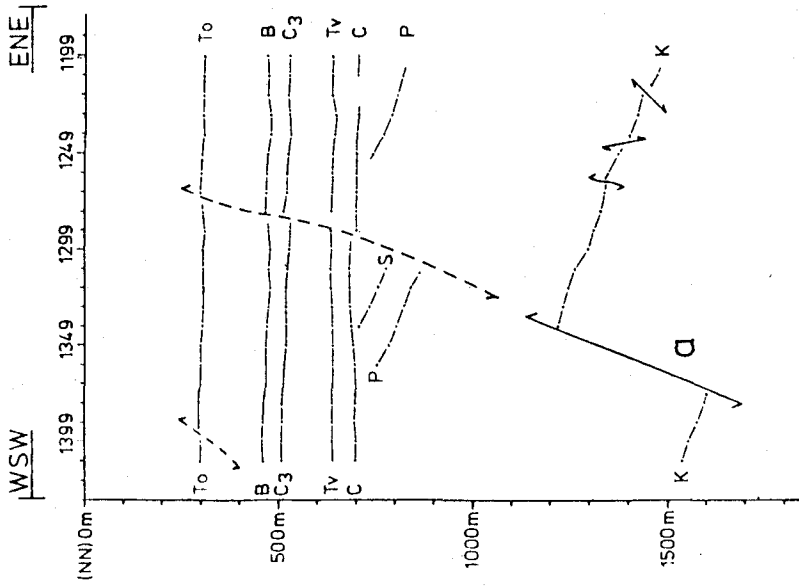

a) Depth section

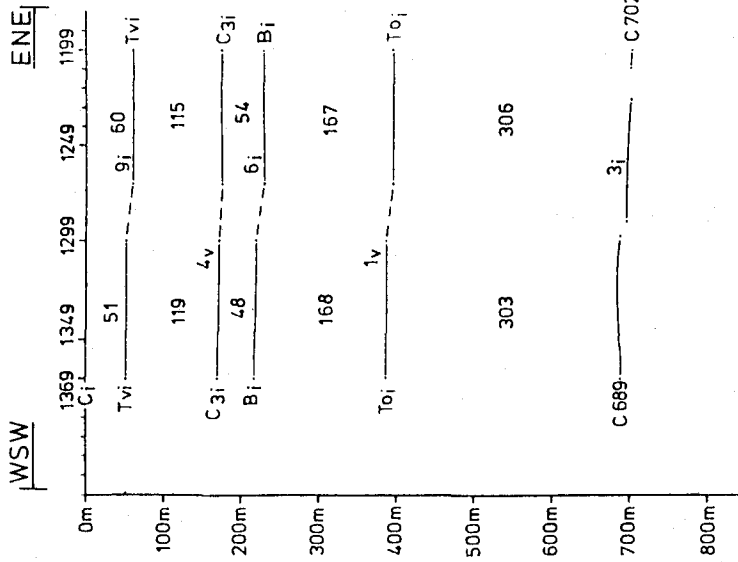

b) Inverse plot of reflection horizons in Upper Cretaceous and Tertiary (see Fig. 36a)

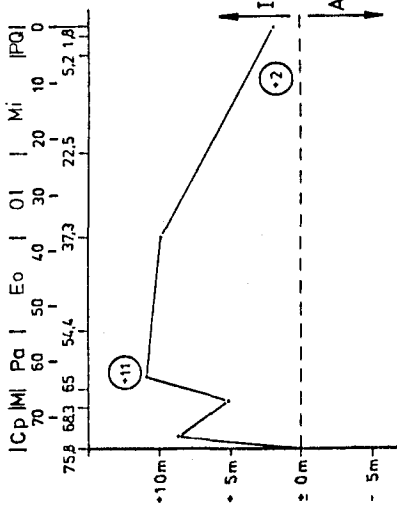

Time abbreviations see fig. 25

Legend:

- See Fig. 17 and 37
- To = base Tongeren (base Oligocene?)
- Inverse plot (Fig. 36b) see text under 2.7

FIG. 36.- Leopoldsburg 1984 - Seismic section 8407 Partial view at western boundary of Donderslag Horst (fault a).

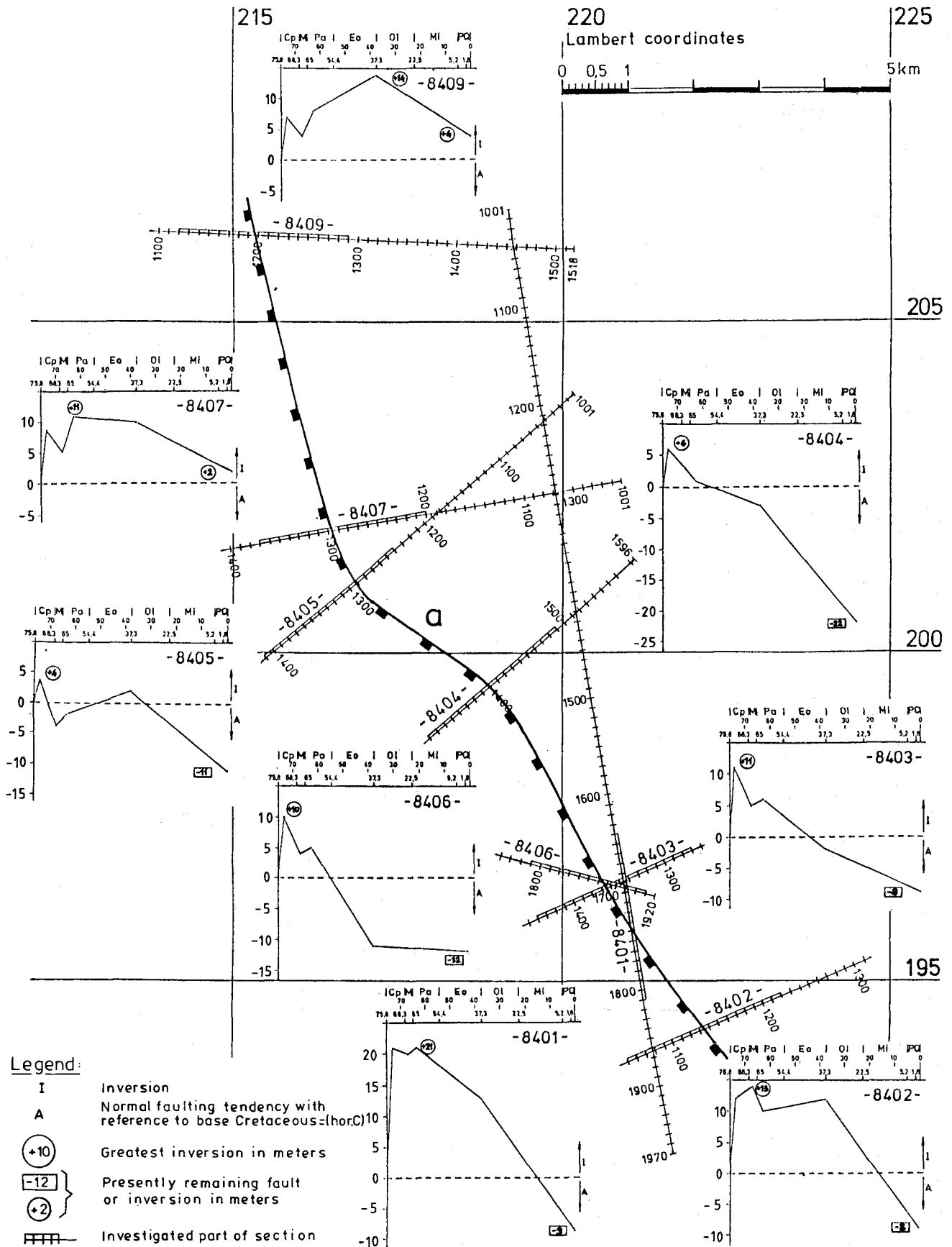
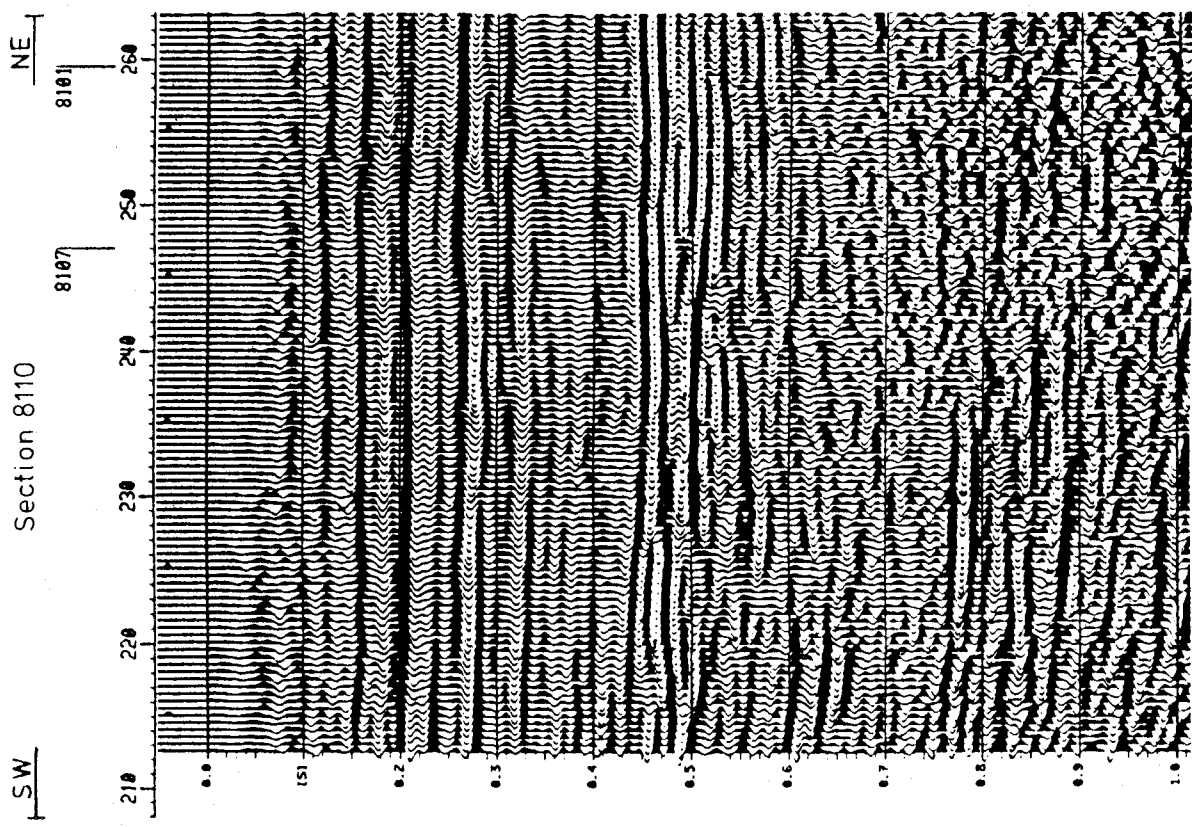
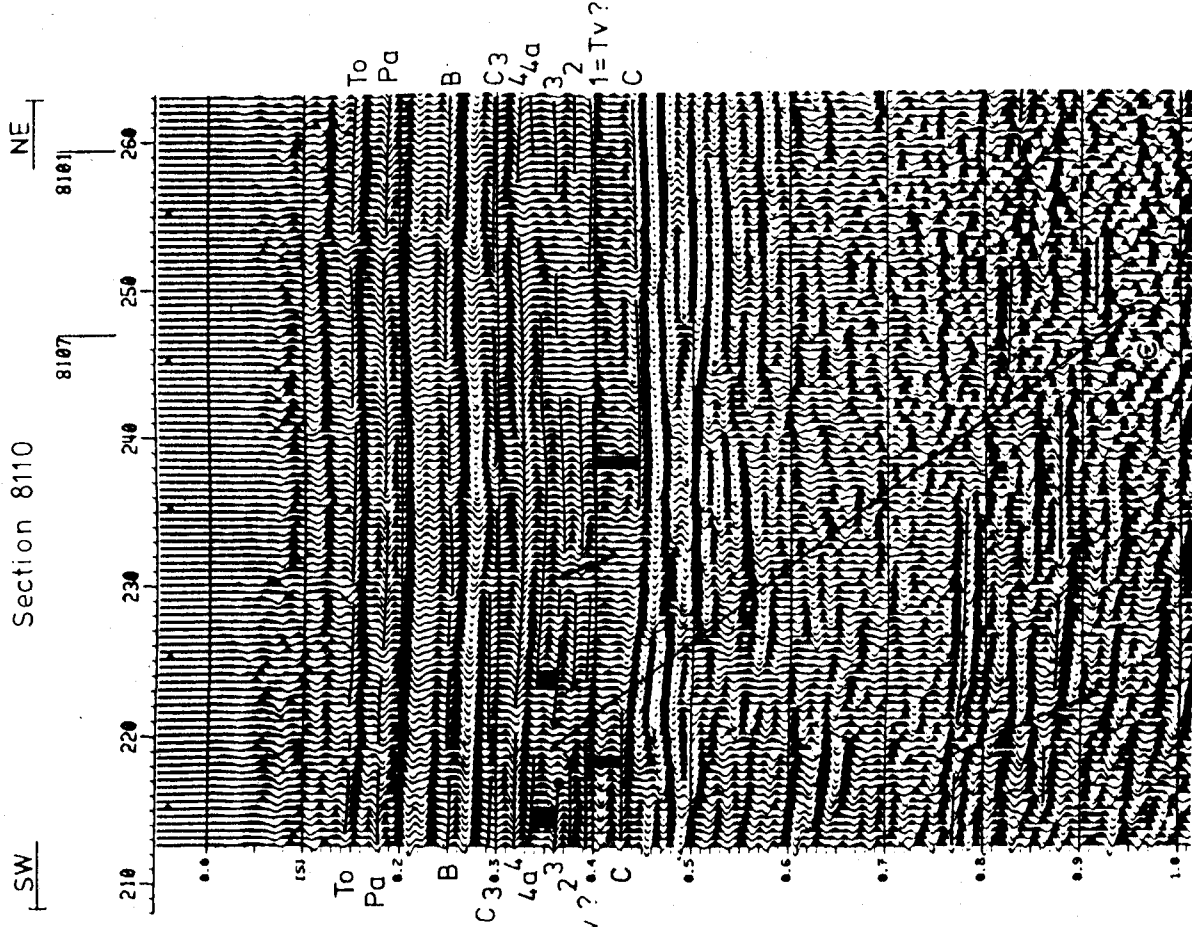

FIG. 37.- Diagrams of Upper Cretaceous-Tertiary movements at western boundary of Donderslag Horst (fault a).



b) interpreted

a) not interpreted

Legend:

- Explanation in text under 3.5.5
- Figs. 17 and 37
- Pa Horizon in Paleocene

FIG. 38.- Eisdén 1981 - Seismic time section 8110
 Inversion in part of Pre-Valkenburg at fault c (see fig. 18).

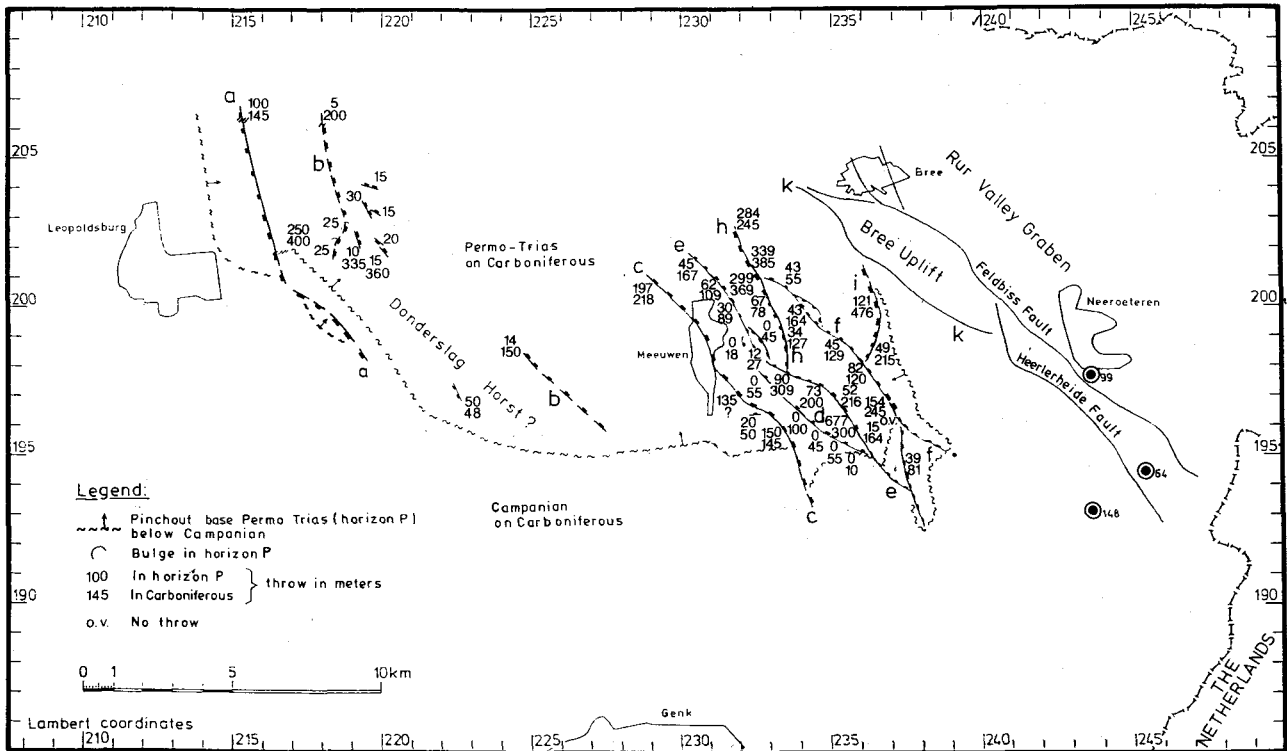

FIG. 39.- Extension of Permo-Trias in Campine coal exploration area with main faults.

deformation - were inactive during the Cretaceous and Tertiary, and that increasing throws of Late Kimmerian faulting increase the mobility of these faults in the Cretaceous and Tertiary even if the observed displacements, both for inversions as well as the subsequent normal faulting tendency remained negligible.

3.7. FORM AND DISTRIBUTION OF UPPER CRETACEOUS-TERTIARY INVERSIONS IN THE CAMPINE

The Upper Cretaceous-Tertiary sequence in the Campine starts in the Santonian or Campanian and extends into the Quaternary. Consequently the Campine covers the stratigraphic gap which exists in the BAG Niederrhein area between Santonian and Oligocene.

Movements in the early Upper Cretaceous prior to the Campanian probably existed at the Late Kimmerian faults, but cannot be recorded in coeval sediments. A stronger inversion found in the Carboniferous than in the overburden might be an indication for their existence (fig. 8c).

At most places stronger inversions exist at the beginning of the Cretaceous in the Vaals formation; the intensity of these inversions then decreases in the overlying beds. From a locally very different time onwards the inversions are substituted by normal faulting tendencies at the

same fault zone. These inversions and normal faulting tendencies are always closely associated in the Campine.

3.7.1.- Graben margin

Both the Cretaceous-Tertiary inversions and the subsequent normal faults have substantial displacements at the Late Kimmerian normal faults forming the graben margin. Inversions persist from the Vaals into the Maastricht formation, and on the Bree Uplift even into the Tertiary.

Disregarding the Bree Uplift no flexure fronts are present like those at the graben margins in the western part of the Rhenish-Westphalian coal district. Similarly the characteristic bulges at the graben margins are missing; Zechstein salt is not supposed to exist in the graben.

3.7.2.- Graben shoulder

On the graben shoulder the Late Kimmerian normal faults have smaller throws than at the graben margin; the inversion and the subsequent normal faulting tendencies are considerably smaller.

The importance of Upper Cretaceous to Tertiary movements decreases with increasing distance from the graben margin. The inversions are frequently limited to the Vaals formation but may reach the Gulpen or Pre-Valkenburg formation. Thus the significance of the long-lasting inver-

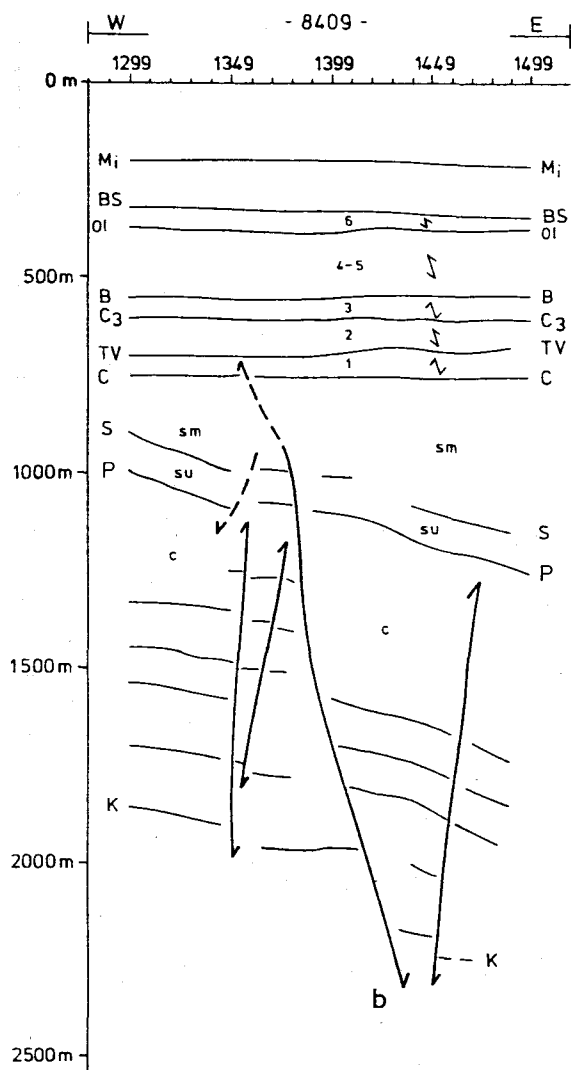

Legend:

- 1 Vaals, normal faulting tendency
- 2 Gulpen, inversion
- 3 Maastricht and Houthem, normal faulting tendency
- 4 Paleocene without Houthem } inversion
- 5 Eocene } inversion
- 6 Tongeren?(Oligocene), inversion

- Mi Base Miocene (Houthalen)
 BS Base Berg Sand
 Ol Base Tongeren? (Oligocene)
 B Base clastic Tertiary (Orp Sand)
 C3 Base Maastricht and Houthem
 TV Top Vaals (base Gulpen)
 C Base Upper Cretaceous (Vaals, Campanian)
 P Base Permo Trias
 K Approximately Quaregnon seam (top Genk unit)
 sm Middle Buntsandstein
 su Lower Buntsandstein
 c Carboniferous

- ↙ Inversion
 ↘ Normal faulting tendency } above horizon C

FIG. 40.- Leopoldsburg 1984 - Depth section 8409
Partial view at fault b (see figs. 18 and 35), exaggerated.

sions decreases while the normal faulting tendency starts earlier. The latter is approximately of the same importance as the inversions, for the depths of the base Cretaceous on either side of a fault zone never differ very much. Occasionally the Cretaceous fault movement may even start with a normal faulting tendency.

At many sites up and downward movement alternates several times before the normal faulting tendency finally prevails. Such alternating movements occur mainly at the graben shoulder. Even on the Bree Uplift, however, a certain amount of up-down movement can be recognized. Inversion as well as the subsequent normal faulting tendency can begin at any point on the fault zone and then shift along it. Inversions can exist at any point on a fault while a normal faulting tendency is active at another point on the same fault.

There is a definite connection between inversions and normal faulting tendencies and the Late Kimmerian deformation. Asturian normal faults which were not reactivated in the Late

Kimmerian orogeny exhibit (where a comparison is possible) neither inversions nor subsequent normal faulting tendencies in the Cretaceous and Tertiary. At places where Late Kimmerian movements become larger along a fault, inversion and normal faulting tendencies also gain importance in the Cretaceous and Tertiary.

The small fault movements during the Upper Cretaceous and Tertiary on the graben shoulder are reminiscent of similar small movements along the fault blocks in the eastern part of the Rhenish-Westphalian coal district.

4.- CONCLUSIONS

The sedimentary sequence in the Münsterland Cretaceous extends in the western part of the Rhenish-Westphalian coal district from the Albian up to the Santonian, locally up to the Lower Campanian. This sequence is separated by a sedimentation gap from the Middle Oligocene. The Cretaceous-Tertiary sequence in the Campine is

more continuous, starting in the Santonian or Campanian and extending to the Quaternary. In this way it is possible to observe the entire inversion sequence.

The Upper Cretaceous inversions in the Münsterland Cretaceous may have their origin in the Cenomanian or more probably in the Late Turonian and reach their maximum between Coniacian and Campanian. These inversions also affect the Limburg Cretaceous in the Campine. The gradual wane of inversions can be followed here into the Tertiary whereby local differences in the movements can be recognized.

In the west of the Rhenish-Westphalian coal district a study can be made of the inversion at the margin of large grabens which were not affected by subsequent Tertiary normal faulting tectonics. Seismic information can be supplemented by mining observations.

The inversions encompass a wide zone on either side of Late Kimmerian faults and appear at the graben margins as flexure fronts in the Cretaceous beds. Graben margins without inversions - such as the Krudenburg Fault - are rare. The inversions are long-lasting movements, have varying displacements along the length of a fault and can turn into contemporaneous normal faults.

In the Campine to the west of the Rur Valley Graben, however, the flexure fronts are missing, with the exception of the Bree Uplift.

Subsequent to the Cretaceous-Tertiary inversions normal faulting or normal faulting tendencies occur everywhere. As opposed to the western part of the Rhenish-Westphalian coal district, these normal faults are closely associated with the inversions in the Campine. At the margin of the Rur Valley Graben the normal faults predominate over the initial inversions. The sole exception is at the northwestern boundary of the Bree Uplift.

In the Campine, however, mainly small inversions on the graben shoulder can be observed. These are reminiscent of the inversions of the fault block tectonics in the eastern part of the Rhenish-Westphalian coal district.

Formation thickness averaging at the Cretaceous-Tertiary transition enables the detection of fault movements with an accuracy of a few meters, at the limit of seismic resolution. Since these thickness differences are always linked to fault zones they supposedly result from vertical movements in the fault zone although it is tempting to make facies differences responsible for the calculated thickness differences.

Inversions, which generally started with the Campanian and usually had their greatest displacements within the Cretaceous, often

exhibit recurrent movements in the Tertiary and are substituted at different times, mainly in the Tertiary, by normal faulting tendencies which frequently compensate the previous inversions.

The finely subdivided Cretaceous and Tertiary sequences occasionally enable the recognition of slight cakewalk movements between the main inversion and eventual normal faulting phases. Also in the Campine lateral transitions between inversion and normal faulting tendencies along a single fault are observed.

The intensity of inversion decreases with increasing distance from the graben margin. The intensity of Cretaceous and Tertiary movements largely depends on the importance of the Late Kimmerian deformation.

ACKNOWLEDGEMENTS

I would like to express my thanks to the Bergbau AG Niederrhein in Duisburg, the N.V. Kempense Steenkolenmijnen in Houthalen-Helchteren and the Belgian Geological Survey in Brussels for the permission to publish the illustrations and results presented.

I am also indebted to Prakla-Seismos AG without whose help the work would not have been possible.

Thanks are also due to Prof. Bouckaert and Dr. Dusar of the Belgian Geological Survey in Brussels, Mr. Klessa as well as the mining surveyors Mr. Rau and Dr. Rüller of BAG Niederrhein in Duisburg. Mr. W. Müller of the Berggewerkschaftskasse Bochum as well as several colleagues of Prakla-Seismos for stimulating discussions about the inversion problem, which necessarily preceded the publication.

BIBLIOGRAPHY

- ARNOLD, H. & THIERMANN, A., 1978.- Kreide, in : Geologie am Niederrhein, *Geologisches Landesamt Nordrhein-Westfalen*, Krefeld.
- BALDSCHUHN, R., FRISCH, U. & KOCKEL, F., 1985.- Inversionsstrukturen in NW-Deutschland und ihre Genese. *Zeitschr. Deutsch. Geol. Ges.*, 136 (1) : 129-139.
- BOIGK, H., 1969.- Das Emsland im Rahmen des Niedersächsischen Tektogens. *Zeitschr. de Deutsch. Geol. Ges.*, Bd 119 : 508-515.
- BOUCKAERT, J., DUSAR, M. & VANDELDE, E., 1981.- Exploration for coal in the Neeroeteren-Rotem area. Preliminary results of a seismic survey carried out in December 1980 - January 1981. *Ann. Soc. géol. Belg.*, 104 : 281-289.
- BREDDIN, H., 1929.- Die Bruchfaltentektonik des Kreidegebirges im nordwestlichen Teil des Rheinisch-Westfälischen Steinkohlenbeckens. *Glückauf*, 65 : 1157-1168 and 1193-1198.
- DELMER, A., 1963.- Carte des Mines du bassin houiller de la Campine. *Ann. Mines Belg.* 1963-6 : 739-754.
- EICHENBERG, W., 1969.- Das Erdölfeld Dalum 1942-1967. *Zeitschr. d. Deutsch. Geol. Ges.*, Bd. 119 : 531-540.

- VAN EYSINGA, F.W.B., 1978.- Geological Time Table. 3ed Edition, Elsevier, Amsterdam.
- FELDER, P.J., BLESS, M.J.M., DEMYTTENAERE, R., DUSAR, M., MEESSEN, J.P.M.Th. & ROBASZYNSKI, F., 1985.- Upper Cretaceous to Early Tertiary Deposits (Santonian-Paleocene) in North-Eastern Belgium and South Limburg (The Netherlands) with Reference to the Campanian-Maastrichtian. *Belgian Geological Survey, Prof. Paper* 1985/1, nr. 214, 151 p.
- KNAUFF, W., 1978.- Jura, in : Geologie am Niederrhein. *Geologisches Landesamt Nordrhein-Westfalen*, Krefeld.
- LEGRAND, R., 1961.- L'épeirogénése, source de tectonique, d'après des exemples choisis en Belgique. *Mém. Inst. Géol. Univ. Louvain*, t. 22 :3-66.
- LOSCHER, 1929.- Die Tektonik des Kreidegebirges im rheinish-westfälischen Ruhrkohlenbezirk. *Der Bergbau (Bergtechnische Wochenschrift)*, nr. 38 vom 19. September 1929.
- MENTZEL, H., 1903.- Die Schichten im Hangenden des Niederrheinisch-Westfälischen Steinkohlengebirges, in : *Die Entwicklung des Niederrheinisch-Westfälischen Steinkohlenbergbau*, J. Springer, Berlin, Bd. 1 :156-216.
- MULLER, J.E., 1945.- De Post-Carbonische tektoniek van het Zuid-Limburgse mijngebied. *Meded. Geol. Stichting, Sercie C-I-N°2*, 32 p.
- PATIJN, R.J.H., 1961.- Bewegingen langs de Heerlerheide- en Geleenstoring in het Mauritsveld. *Meded. Geol. Sticht.*, N.S. 13 :35-38.
- PAULISSEN, E., 1973.- De morfologie en de kwartairstratigrafie van de Maasvallei in Belgisch Limburg. *Verhand. Kon. VI. Acad., Klasse Wet.*, Jg. 35, Nr. 127, 266 p.
- PILZ, 1906.- Neuere Mergelabstürze im Niederrheinisch-Westfälischen Steinkohlengebirge, *Glückauf*, 42 : 502-505.
- SOLL, H., 1962.- Die Erdgaslagerstätte Emlichheim. *Herman-Aldinger-Festschrift*, Stuttgart : 173-183.
- TYS, E., 1980.- De geologische structuur van het steenkoolterrein ten noorden van het ontginningsgebied der Kempense mijnen. *Belg. Geol. Dienst, Prof. Paper* 1980/9, nr. 179, 43 p.
- VOIGT, E., 1962.- Frühdiagenetische Deformation der turonen Plänerkalke bei Halle/Westf. als Folge einer Grossgleitung unter besonderer Berücksichtigung des Phacoid-Problems. *Mitt. Geol. Staatsinst.*, Heft 31 : 146-275.
- VOIGT, E., 1963.- Über Randtröge vor Schollenrändern und ihre Bedeutung im Gebiet der Mitteleuropäischen Senke und angrenzender Gebiete. *Zeitschr. d. Deutsch. Geol. Ges.*, Bd. 114/II : 378-418.
- VOIGT, E., 1970.- Untermeerische Grossgleitungen in der Kreide Westfalens und die dabei erfolgte Deformation der Sedimente. *Mitteilungen der deutschen Akademie der Naturforscher, Leopoldina*, Reihe 3, Jg. 15/1969.
- WOLANSKY, D., 1960.- Ein «Umkehrverwurf» im Deckgebirge am Ostschacht der Zeche Adolf von Hansemann. *Glückauf* 96 : 1006-1010.
- ZIEGLER, P.A., 1982.- Geological Atlas of Western and Central Europe. *Elsevier Amsterdam*.