

Microphysical operational structures and scale consistency. Study of equations of kinetics and transport in propagating environments in order to make a morphological bivalent approach of epidemic process

Bonnardot Jean(*), Sabatier Philippe(**)

(*) Laboratoire RFV, Institut National des Sciences Appliquées de Lyon
20, Avenue Albert Einstein F-69621 Villeurbanne Cedex
E-mail : JBonnardot@cipcinsa.insa-lyon.fr

(**) Unité BioInformatique, Ecole Vétérinaire de Lyon
1, Avenue Bourgelat, F-69280 Marcy l'Etoile
E-mail : sabatier@clermont.inra.fr

Abstract

In epidemiology (or in biology of populations), an usual process consists in building up local parametrized models, which analysis permits to derive some noteworthy states by weighting speeds of dynamics. The potential existence of complex structures with several chaotic evolution schemes leads to a macroscopical approach by means of non linear dynamic systems. Provided that one calculates different types of means according to some protocols which can be only based on the underlying micro-structures, a way of resolving by the use of multiple scales is efficient. The direct micro bottom-up processing, by means of distribution functions, leads to some relations which are very interesting for physics of collisions, but it doesn't permit to satisfy macroscopic scale constraints, even after successive integrations. We quote pressure as an example.

Keywords

Molecular disorder, free path, morphogenesis meso/macroscopic, stochastic appending, scales transfer, correlation range, diffusion of intensive or extensive character, Navier's equation, vorticity and turbulence.

Introduction

Through this century the formal analogies between the mathematical models in population dynamics and certain models of different physical processes have been source of inspiration both for biologists and physicist. The purpose of this paper is to apply some techniques from the non-equilibrium statistical mechanics to the study of space-dependant propagation of an epidemic in a large system. The main concern is the study of time behaviour of the numbers of the different types of individuals (susceptible, infective, immune, recovered, etc...) which make up an epidemic system. This study started with ordinary differential equations (Kermack, McKendrick, 1927), but had been generalised

with stochastic field equation (Barlett, 1955, Bailey, 1957), partial differential equations (Källén & al., 1985, Murray, 1993), and cellular automata (Kuulasmaa, 1982, Boccara, 1992).

1. Transposition of scales t , s , v , λ in micro-physics of diluted environments

The shaky basis of the General Epidemic Process is that all individuals are assumed to "move" randomly and to "contact" other individuals of various types in proportion to their density ; upon contact the infective agent is transmitted with a certain probability, i.e. given a "collision" the "reaction" takes place with a certain probability. Note that here the "incidence" refers to the number of new cases per unit of time per unit of area (when the spatial domain is two-dimensional).

Each of these scales hasn't necessarily an equivalent in biology.

E_t , E_s , E_v are linked by a relation : $E_v = E_s / E_t$ (for example), which allows to infer E_v from the two others.

t_c is time of a collision between α and a particle β .

t_ℓ is time separating two collisions between α and one (or several) particle(s) β .

The evaluation of \bar{t}_c^α , which is a set mean calculated on a population under given conditions, may be evaluated in two ways.

1. By a geometrico-kinetic analysis

The infection process has a local character and thus a susceptible individual can be infected only by the infections individuals from its vicinity. We use two different representation of the positions of the individuals : a continuous distribution of the individuals ; and a discrete space into small cells arranged into an d_s -dimensional regular lattice. In the continuous case we assume that the vicinity in which the infection process takes place in a small domain D surrounding the healthy individual considered. The size V_D of the vicinity is much smaller than the size of the domain Σ . For discrete space description, this vicinity is made up of the first layer of $\mathcal{M} = 3^{d_s} - 1$ cells surrounding the central cell considered. For each distribution of infected individuals in the vicinity of a healthy individual there is a certain probability of infection.

We introduce :

- a spatial scale ϕ for α ,
- a type of interaction m within population : elastic shock for spherical α particles (contacts reaction),
- a sphere of collision (or interaction) of radius a . (infection sphere).

A mean counting of population into an impact cylinder (Fig.1), during a laps of time δt such that $t_c < \delta t$ gives us : $\delta N = n_{eq} \pi a^2 \delta t v_r \beta$ where n_{eq} is a density at equilibrium, and β is a particle which might shock α .

The weakening of counting by choosing density at statistical equilibrium and by taking into account the non uniformity of speeds within population leads to an adaptive kinetics :

$$v_{r\beta} \longrightarrow v_{th} = v_q = \overline{v^2}^e = \frac{V}{N} \int v^2 F(v) dv \frac{V}{N} = \frac{3}{2m} \times \frac{1}{\beta}$$

$$t_c = \frac{\delta t}{\delta N} = \frac{1}{n_{eq} \sigma v_{th}} \text{ where } \sigma = \pi a^2 \text{ where is the efficient section of collision}$$

$$l = t_c v_{th} \text{ with } t_c \approx 2.10^{-10} \text{ sec.}, \text{ and } v_{th} \approx 650 \text{ m/s (for a gas)}$$

2. By evaluating the probabilities of t-random events

An infected individual placed at position r has a constant probability $\alpha(x) \Delta t$ of healing in a small time interval of length Δt ; similarly an immune recovered individual placed at position x has a constant probability $\gamma(x) \Delta t$ of resensibilization in a small time interval of length Δt . These two probabilities are independant of the states and positions of over individuals from the system. Each individuals can migrate from a position to other positions within the domain Σ . For an individual in the state the rate of migration in a small time interval of length Δt from a position x' to a position $\varepsilon [x, x+dx]$ is denoted by $W(x' \rightarrow x) dx \Delta t$

We assume that this rate depends on the state of the individual considered as well as on the initial and final position vectors x' and x , respectively. For the case of a discrete space representation, the position vectors are discrete and correspond to the centres of the cells, and thus we should leave out the differential elements of volume dx . Note that in the discrete case the physical dimension of the rate W is different because it includes the factor $[length]^d_s$ due to the dropping of the factor dx .

The shock process is formalised by a coefficient μ which is the density of shock probability. Let be :

$N(t)$ the probability for α to collide no particle on $[0, t]$,

$\omega_\alpha(dt)$ the probability for α to collide on $[t, t+dt]$.

Then :

$$\omega_\alpha(dt) = \mu dt = \frac{1}{\tau} dt ; \mu \text{ doesn't depend on } t \text{ (stationary)}$$

$$N(t+dt) = N(t)(1 - \omega_\alpha(dt)) = N(t)(1 - \mu dt) \text{ (Pre-markovien),}$$

$$\frac{dN}{dt} = -\mu N(t) \Rightarrow N(t) = N_0 e^{-\mu t} = N_0 e^{-t/\tau}$$

$$\langle t \rangle = N_0 \int_0^{\infty} t e^{-t/\tau} dt = \tau$$

The collision mean time of a particle α is a relaxation time of no-collide probability law $N(t)$. This approach lead to macroscopic scale. They delete the micro-physical conditions (ϕ molecular diameter, v_{th}) thermal speed), giving preference to statistical phenomenology. A physical relaxation on mean speed of a coarse particle immersed in a medium of light particles gives :

$F(t) = -\gamma v(t) + R(t) = m dv/dt$; $R(t)$ is the stochastic corrective of a newtonian balance.

$$v(t) = v_0 e^{-\frac{\gamma}{m}t} + v_0 e^{-\frac{\gamma}{m}t} \times A(t) \quad \text{with} \quad A(t) = \int_0^t R(\alpha) \cdot e^{\frac{\gamma}{m}\alpha} \cdot d\alpha$$

We have two temporal scales :

- long : $\tau = \frac{m}{\gamma}$, relaxation time of $\bar{v}^e \geq t_e$

- short : autocorrelation range G of random force $R(t)$ linked with collision time according to : $G(t-t') = \overline{R(t)R(t')^e}$

2. Stochastic equations with scales transfers

The hierarchical organisation in epidemiology of scales of pre-conditioned entities by statistical physics, call itself the conceptual, and computational, contents of extrapolate basic equations. The probabilistic approach of evolutionary law organise its balances around two families of relations.

Family 1. Deterministic relations of stochastic balances of geometric and/or kinetic states during temporal oscillations.

1. On the ρ -probabilities of the bi-dated transitions :

W_1 : transition density define at the sub-macroscopic scale (W_2 bi-transition density), but not t-density in the master equations.

W_2 verify the integral relation :

$$\iint W_2(x, v; t / x', v', t') \times W_2(x', v', t' / x'', v'', t'') dx' \cdot dv' = W_2(x, v; t / x'', v'', t'')$$

2. On the bi-occupation probabilities $f(x, v; t)$

$$f(x + \Delta x, v; t + \Delta t) = \iint_{\Delta x \times \Delta v} f(x, v - \Delta v; t) W_2(x, v - d(\Delta v); t / x + d(\Delta x), v; t + \Delta t) d(\Delta x) d(\Delta v)$$

For a subsequent conjunction with a Langevin equation, we pass x , and we precede the speed states.

For short, Δt at the microscopic scale, Δx et Δv are small. Between the others methods, the limited developments give different local relations, with a very evident formula :

$$\frac{\partial f}{\partial t} + v \frac{\partial f}{\partial x} = \frac{Df}{Dt} \approx - \frac{\overline{\Delta v^e}}{\Delta t} \frac{\partial f}{\partial v} + \frac{1}{2} \frac{\overline{(\Delta v)^2^e}}{\Delta t} \frac{\partial^2 f}{\partial v^2} = a(\Delta t) + b(\Delta t)$$

The limits when $\Delta t \rightarrow 0$ is a and b , at the macroscopic scale, can be find in the relation on the top of the mesoscopical scale. And naturally in $E_{t,s}^M$ to translate the emergences M of the microbehaviors (t, s) dependent. The statistical mean of the Langevin formula without outside field L_0 : give $a(\Delta t) = 2D_v$ speed diffusion rate. This is a Fokker-Planck formula (associated to L_0) :

$$\frac{\partial f}{\partial t} + v \frac{\partial f}{\partial x} = \frac{\partial}{\partial v} \left(\frac{\gamma}{m} V f \right) + D_v \frac{\partial^2 f}{\partial v^2} + a(\Delta t) \frac{Df}{Dt} = \text{div}_v \left(\frac{\gamma}{m} \vec{V} f \right) + D_v \Delta f$$

The first term $\text{div}_v \left(\frac{\gamma}{m} \vec{V} f \right)$ is comprehensive as a convective derivative in the positions space (derivative term). The second term $D_v \Delta f$ carry the kinetic diffusive property of f , pour $t \gg \tau = \frac{m}{\gamma}$ relaxation time of the initial speed (diffusive term).

Family 2 of the stochastic equations with a correcting of a newtonian balance (Langevin, Kubo et Mori).

1. Out of the field : $m \frac{dv}{dt} = \overline{R(t)} + \underset{\approx}{r(t)} = -\gamma v(t) + \underset{\approx}{r(t)}$

2. On the internal and central field : $m \frac{dv}{dt} + kx(t) = \overline{R(t)} \rightarrow m \frac{d^2x}{dt^2} + \gamma \frac{dx}{dt} + kx = \underset{\approx}{r(t)}$

These microscopic equations are archetypal in physics. The integro-product association, doubling variables, statistical means, allow the scales transfers, and constitute for the biological modelling a methodological basis which associate with an equilibrate method the concept and the computational process.

By calculating $\overline{x^2(t)^e}$ we note that in the two parallel process, the thermalisation at different stages give the same deterministic temporal law, we discuss the stability of the operators applicated to the stochastic equation. This mathematical stability is induced by the linearity, and by the hypothesis made on the two first momentum of the process. At the final macroscopical law, the pre-tangential join, for the law $\overline{x^2(t)^e}$, between the short and long times, implicate that we can balance the boundary conditions of an intermediate level.

The General Epidemic Process can be discussed in the terms of a field theory. In the epidemic model we have two fields : one for the spreading process (ψ); and one for the removed process (ϕ). After being produced by an infective, the individuals are inert, its neither diffuses, decays, not reproduced itself. But it can act on the infective individuals by modifying its reproductive (death) rate, and any other parameters influencing its spreading. Thus we can model the spreading :

- for ψ , by a Langevin equation :
$$\frac{\partial \psi}{\partial t} = D \nabla^2 \psi - \sigma \psi + \rho(\phi) \psi^2 + \eta(x,t)$$

where D is a diffusion coefficient and $\eta(x,t)$ is a Gaussian noise whose variance is proportional to ψ

- and for ϕ :
$$\frac{\partial \phi}{\partial t} = g \psi$$

3. Emergence of sub-microscopic quantities and regimes through dynamical or transport equations

The probabilistic approach adopted in chapter 2, and the various expression of spatio-temporal dependance about occupation or transition density with 1, 2, ..., n states, leads to micro / macro emergences. Taking limit at long-time, the Fokker-Planck equation gives again the diffusion equation established in macroscopic phenomenology, that is a kind of validation. But this ascending deductive process disconnected from macroscopic constraint of spatio-temporal scale give us some difficulties :

- (1) to characterise on a fine and balanced manner the intensive properties mainly detected at macroscopic scale such as pressure for example ;
- (2) in elaboration of test quantities revealing states change or pathological regime in chaos.

The pressure introduced in macroscopic theories of gas, has received synthetic formulae by way of statistical physics. The biological context lead us to catch again the basic stages of the theories.

$P = \frac{dF}{d\sigma}$ dF is a macroscopic emergence of momentum transfers, of particles toward a test surface, collisions (or interactions) during a short but macroscopic lapse of time.

$\vec{dF} = \sum_{t_\mu} \vec{f}_c(t_\mu) \vec{f}_c$ is associated with the lifetime dt in a sub-macroscopic frame (percussions).

$\vec{\omega}(t_c) = -\vec{f}_c(t) \cdot dt$ the link with the classical dynamics applied to α particle a with a mass m , convergent towards $d\sigma$ in the direction $\begin{pmatrix} \theta \\ \varphi \end{pmatrix}$:

$$\frac{d(mv_\alpha)}{dt} = \vec{f}_\alpha(t_\mu) \cdot dt \rightarrow \int_{before}^{after} d(mv_\alpha) = mv_\alpha(t_{before}) - mv_\alpha(t_{after}) \cong \vec{f}_\alpha \cdot dt = -\vec{\omega}_\alpha(t_c)$$

with an elastic collision against an smooth surface :

$$\rightarrow \left\| \vec{v}_\alpha(t_{before}) \right\| = \left\| \vec{v}_\alpha(t_{after}) \right\| \quad \vec{f}_\alpha \perp d\sigma$$

$$\vec{\omega}(t_c, dt) \cong 2m v_\alpha(\theta, \varphi, t_{before}) \cdot \vec{n}$$

P is define as a temporal mean on a macroscopic lapse T , of the sum of percussions developed during T , for all the α -particles, in all the directions of the half-space viewing $d\sigma$.

$$Pd\sigma = \frac{1}{T} \sum_{dt} \sum_{\alpha} \sum_{(\theta, \varphi)} 2m \vec{v}_\alpha(\theta, \varphi, t_b) = \frac{1}{T} \sum_{dt} J$$

J will be evaluated by a position and speed repartition function $f(r_1, r_2, \dots, r_N, v_1, v_2, \dots, v_N; t)$. The framework show a process which sort particle categories $\alpha(\theta, \varphi)$ at t taking account their capacity to collide with $d\sigma$ at a time $t+dt$. It is difficult to formulate this process with the Cartesian bi-functionality of f . Mathematically, the polar expression should be well adapted, but it introduce conical singularities which aterate the kinetics. We suggest the intermediate process.

$$J = 2m \frac{N}{V} \int_{\vec{v} \cdot \vec{n} \geq -\zeta, V} \vec{v} \cdot \vec{n} f(x, y, z, v_x, v_y, v_z) \pi dx_i \pi dv_{x_i}$$

$$= k_0 \int_{(\theta, \varphi)} \pi dx_i(\theta, \varphi) \int_{\vec{v} \cdot \vec{n} \geq -\zeta, V} \vec{v} \cdot \vec{n} f(x, y, z, v_x, v_y, v_z) \underline{dx} \underline{dy} \underline{dz} \quad (\theta, \varphi)$$

$$= k_0 \int_{(\theta, \varphi)} \pi dv_{x_i} H$$

$$H = \left(\frac{\vec{v} \cdot \vec{n}}{v} \right)^{\alpha(\theta, \varphi)} \cdot M, \quad M: \text{population of cylinder ability to collide with } d\sigma, \text{ under } (\theta, \varphi)$$

during the laps $[t, t+dt]$; $M = \left(\frac{\vec{v} \cdot \vec{n}}{v} \right)^{\alpha(\theta, \varphi)} T \cdot d\sigma \cdot \bar{v}_n$; $\bar{v}_n = \frac{N}{V}$ numerical macroscopic density.

$$J = k_0 \cdot d\sigma \cdot T \cdot \bar{v} \int_{(\theta, \varphi)} \left(\frac{\vec{v} \cdot \vec{n}}{v} \right)^{\alpha(\theta, \varphi)} \underline{dv}_x \underline{dv}_y \underline{dv}_z \quad (\theta, \varphi)$$

$$J = k_1 \cdot \frac{1}{4\pi} \int_{(\theta, \varphi) \in (S^2 \text{Space})} \left(\frac{\vec{v}^{\alpha(\theta, \varphi)}}{v} \cdot \vec{n} \right)^2 \sin \theta \cdot d\varphi \cdot d\theta = \left(\frac{\vec{v}^{\alpha}}{v} \right)^2 \times \frac{1}{6}$$

$$p \cdot d\sigma = \frac{1}{T} \cdot \frac{1}{3} \cdot m \cdot \frac{N}{v} \cdot d\sigma \cdot T \sum_{\alpha} \left(\frac{\vec{v}^{\alpha}}{v} \right)^2 = \frac{1}{3} \cdot m \cdot \frac{N}{v} \cdot \frac{d\sigma}{T} \cdot E$$

We regularise E by means of integral $\int_t^{t+T} \left| \frac{\vec{v}^{\alpha}}{v} \right|^2 dt$

Finally :

$$P = 2m \cdot \frac{N}{V} \cdot \frac{1}{6} \cdot \frac{1}{T} \int_0^T \left(\frac{\vec{v}^{\alpha}}{v} \right)^2 dt = \frac{1}{3} \cdot \frac{Nm}{V} \cdot U_q^2 \quad U_q \text{ is the mean square speed.}$$

After a critical analysis of integration of a micro-kinetic equation for a diluted gas (Boltzmann), and those of modelling the conservation of a property μ in a fluid (a contaminate medium), a local kinetic splitting (s) create the emergence of a convective current jointly with diffusive current. From comparison between the microscopic and macro-local formulation, about Navier-Stocke's equation of Newtonian fluid, we draw through an interpretation of coefficients, relative weight giving some mark for emergence of flow or propagation regime.

$\sigma = \{\alpha_n\}$ is a population of particles on a region Ω . We can not access by a deterministic way to the kinematics of the process, or energetic evolutions of each interactive particle α (N bodies problem). These poly-interactions are modelled with a distributed mean field. The hypothesis of independant α particles drive to solve a one-body problem, through the factorisation of the position and speed distribution function :

$$f^N(\vec{r}_1, \dots, \vec{r}_\alpha, \dots, \vec{r}_N; \vec{v}_1, \dots, \vec{v}_\alpha; t) = \prod_{\alpha} f^{\alpha}(\vec{r}_\alpha, \vec{v}_\alpha; t)$$

During the evolution of σ , the particle number conservation in a 6N-cell through phase space $\xi = \vec{r}, \vec{v}; t'$ gives the Liouville-Boltzmann's transfer equation : at microscopical scale.

$$Df_v^{\alpha}(\vec{r}, \vec{v}; t) = \frac{\partial f^{\alpha}}{\partial t} + \vec{V} \cdot \vec{\nabla}_r \cdot f^{\alpha} + \frac{\vec{F}}{m} \cdot \vec{\nabla}_v \cdot f^{\alpha} = \left(\frac{\partial f}{\partial t} \right)_{col} = Cf \quad (1)$$

the second member written conventionally receive some expressions : for short range interaction : $\int_{V_1 \Omega'} (f' \cdot f_1' - f \cdot f_1) v_{rel} \sigma_{(\Omega)} d\Omega' dV_1$ with $v_{rel} = V - V_1$, V_1 is the barycenter

speed of cells paving ξ .

The modelling of high interaction range is included in the field \vec{F} , and will be neglected in the following part. The integration of (I) create the emergence of the macroscopic fields usual transfer theory.

$Df_v^1 \cdot d^3v = C_f d^3v$ = rate of increase of particle density generated by collisions.

We express the conservation of the total number of particles :

$$\int C_f d^3v = \int \left(\frac{\partial f}{\partial t} + \vec{V} \cdot \nabla_r f \cdot d^3v \right) = 0 \quad \text{(II)} \quad \vec{V} \text{ is the speed of a space configuration cell.}$$

Kinetic property finest than the macroscopic speed by means of $f(\vec{r}, \vec{v}; t)$ we deduce the macroscopic density of :

$$(1) \text{ mass } \rho_n(\vec{r}; t) = N \cdot m_\alpha \int f(\vec{r}, \vec{v}; t) d^3v$$

$$(2) \text{ mass flow : } \vec{J}_N = N \cdot m_\alpha \int \vec{v} f(\vec{r}, \vec{v}; t) d^3v$$

In fact, the counting of particles α in a neighbouring dw is not instentaneous, but needs a delay linked to a stabilisation. We improve the modelling by taking a temporal mean :

$$\rho_n(\vec{r}; t) = \frac{1}{\Delta T} \int \rho_n(\vec{r}; u) \cdot du$$

Developing (II)

$$N \cdot m_\alpha \left(\frac{\partial}{\partial t} \int f d^3v + \int \vec{V} \cdot \nabla_r f \cdot d^3v \right) = 0$$

$$\Rightarrow \frac{\partial}{\partial t} \rho_n + N \cdot m_\alpha \left(\frac{\partial}{\partial t} \iiint \text{div} f \cdot \vec{v} \cdot d^3v - \iiint f \cdot \text{div} \vec{v} \cdot d^3v \right) = 0 ; \text{ giving the balance equation}$$

for the mass : $\frac{\partial \rho_n}{\partial t} + \text{div} \vec{J}_{N(M, \mu)} = 0$ and after a temporal mean :

$$\frac{\partial \rho_n}{\partial t} + \text{div} \left(\vec{J}_N \right)_{(M, t)} = 0$$

$\vec{J}_{N(M, t)} = \vec{J}_m(\vec{r}, t)$: vectorial field modelling at macroscopic scale the transfer of mass

carrier, or s-germ carrier $\vec{J}_s(\vec{r}, t)$. \vec{J}_s is correlated to the Eulerian's kinematics of

population $w(\vec{r}, t)$ by $\vec{J}_s = \rho_s \vec{W}$ ρ_s = voluminal density of s-germs

$\left(\rho_s = \frac{ds}{dm} \cdot \frac{dm}{dv} = q_s \cdot \rho_v \right)$ with ρ_v : mass of unity of volume for the carrying population.

The field $\vec{W}_{(M, t)}$ has macroscopic ambiguity, resulting from the definition of material point, and those of the medium. With the individualisation of a parcel ω (neighbourhood of a material point). we can distinguish between the barycenter speed, from those of pack of micro-particles moving on ω and induce the splitting : $\vec{W}(\vec{r}, t) = \vec{W}_g(\vec{r}, t) + v_r(t)$; v_r define the fine evolution of speed field, on ω , and could assume the scattering of s-character from ω to ω' . We found this splitting, with the coherence between two transfers

usually associated : mass transfer, and s-character transfer : (ρ_s, \vec{J}_s) , the balance equation of s is :

$$\begin{aligned} \frac{\partial \rho_s}{\partial t} + \text{div} \vec{J}_{s(M,t)} &= 0, \text{ (or } \delta_s : \text{ source term) give : } \rho_v \frac{\partial q_s}{\partial t} + q_s \frac{\partial \rho_v}{\partial t} = -\text{div} \vec{J}_s \\ \Rightarrow \rho_v \left(\frac{\partial q_s}{\partial t} + \text{grad} q_s \cdot \vec{W}_g \right) &= -\text{div} \vec{J}_s + q_s \cdot \text{div} \rho_v \cdot \vec{W}_g + \rho_v \cdot \text{grad} q_s \cdot \vec{W}_g \\ = -\text{div} \vec{J}_s + \text{div} \vec{J}_s \rho_v \cdot q_s \cdot \text{div} \rho_v \cdot \vec{W}_g &\text{ and } \rho_v \frac{dq_s}{dt} = -\text{div} \left(\vec{J}_s - \rho_s \cdot \vec{W}_g \right) \end{aligned}$$

$\vec{J}_{gs} = \rho_s \cdot \vec{W}_g$ is the transfer of s by means of medium motion (convection). This development reveal the relative current : of diffusion of the character s relatively to the parcel w : $\vec{J}_d = \vec{J}_s - \vec{J}_{gs} = \rho_s \cdot \vec{v}_r$

The same splitting (s) with a stochastic implication, gives a modelling for the turbulent kinetic : $\vec{W} = \vec{W}_g + \vec{v}$ of an incompressible fluid, by means of tensorial formula

$$\vec{\Gamma}(t) = \frac{\partial \vec{W}}{\partial t} + \text{div} \vec{W} \otimes \vec{W}. \text{ After a set mean, and a substitution in Navier's equation, we}$$

reinvest the Reynold's equations. Their closing has implied the use of correlation functions.

The extension of scalar field convective derivative :

$$\frac{D\rho}{Dt} = \frac{\partial \rho}{\partial t} + \nabla \rho \cdot \vec{W} \text{ (with, for example, } \rho_{(M,t)} \text{ the mass density of a fluid F, and } \vec{W}_{(M,t)}$$

the kinematics fluid modeling)

to a vectorial field $\vec{A}_{(M,t)}$ gives the formula :

$$\frac{D\vec{A}}{Dt} = \frac{\partial \vec{A}}{\partial t} + \overline{\vec{d}\vec{A}} \cdot \vec{W}$$

where $\overline{\vec{d}\vec{A}}$ is a dual tensor of second order (Frechet's differential of $\vec{A}_{(M,t)}$

with respect to M. $\overline{\vec{d}\vec{A}} \cdot \vec{W}$ contraction of $\overline{\vec{d}\vec{A}}$ with the vector \vec{W} receive a Cartesian

matrical expression $\left[\begin{matrix} \vec{e}_1, \vec{e}_2, \vec{e}_3 \end{matrix} \right] \left[\overline{\vec{d}\vec{A}} \right] \left[\begin{matrix} \vec{W} \end{matrix} \right]$ (the first matrix will be leave out in the

following text).

Also for $\vec{A} = \vec{W}$ the expression of acceleration in Euler's kinematics is ;

$$\frac{D\vec{W}}{Dt} = \frac{\partial \vec{W}}{\partial t} + \overline{d\vec{W}} \cdot \vec{W} = (I) + (II) \quad (A)$$
 or using a differential operator acting upon a second order tensor (II) with an expression more adapted to an incompressible fluid (F_{inc})

$$div \vec{T} = \sum_i \sum_j \frac{\partial T^{ij}}{\partial x_j} \cdot \vec{e}_i \text{ for } \vec{T} = T^{ij} \cdot \vec{e}_i \otimes \vec{e}_j \text{ with } \otimes \text{ tensorial product between two vectors.}$$

Then $div W \otimes W = \overline{d\vec{W}} \cdot W + W \cdot div W = \overline{d\vec{W}} \cdot W$, for $T = \vec{W} \otimes \vec{W}$;

$$F_{inc} \Rightarrow \frac{D\rho}{Dt} = 0 \Rightarrow div \vec{W} = 0$$

$$(A) \cup (B) \Rightarrow \vec{\Gamma} = \frac{D\vec{W}}{Dt} = \frac{\partial \vec{W}}{\partial t} + div \vec{W} \otimes \vec{W} \quad (C) \text{ (basic equation)}$$

For the modeling of a turbulent flow, we split up the fields \vec{W} according to :
 $\vec{W}_{(M,t)} = \vec{W}_{(M,t)} + \vec{v}_t$; $\vec{W}_{(M,t)}$: fields of average speeds ; quasi stationary on $\Omega = \bigcup_{\alpha} \omega_{\alpha}$, domain of the fluid F_{inc} , written $\vec{U}_{(t)}$; \vec{v}_t written \vec{v}_t is the local field of turbulent speeds.

Following $\vec{v} = 0$, $\vec{W} \otimes \vec{W} = U \otimes U + U \otimes \vec{v} + \vec{v} \otimes U + \vec{v} \otimes \vec{v}$

The emergence of macroscopic property : pressure through a turbulent kinetics, is obtained with a temporal means on a lapse of time t depending on accuracy of measures.

$$\overline{\vec{W} \otimes \vec{W}} = U \otimes U + \overline{\vec{v} \otimes \vec{v}} \Rightarrow \vec{\Gamma}_{(M,t)} = div U \otimes U + div \overline{\vec{v} \otimes \vec{v}} \quad (D) ;$$

$\overline{\vec{v} \otimes \vec{v}}$ is the covariance of the local field \vec{v}_t , therefore $div U \otimes U$ is the acceleration of macroscopic motion : $\vec{\Gamma}_{(M)}$.

Carrying (D) in the temporal means of Euler's equation :

$$\vec{\Gamma} = f - \frac{1}{\rho} div \vec{T} = div U \otimes U + div \overline{\vec{v} \otimes \vec{v}} \quad (E)$$

We deduce $\vec{\Gamma}_{(M)} = f - \frac{1}{\rho} div \left[\vec{T} + \rho \cdot \overline{\vec{v} \otimes \vec{v}} \right]$ where appear an affine correction of stress tensor : the Reynold's tensor. So the means motion is depending on turbulent kinetics.

To reach the movements equations of fluid, we must make an hypothesis on its thermo-mechanical behavior. The usual linearity between tension and deformation for Newtonian fluid, in an isotropic medium, is expressed by :

$$\vec{T} = pI - \eta_v \nabla \cdot \vec{U} I - 2\eta (\nabla U)_s, \text{ with } \nabla \cdot \vec{U} = \text{div } \vec{U},$$

$(\nabla U)_s$: symmetric part of ∇U (or dU).

$$\nabla \cdot \vec{T} = -\nabla p - \eta_v \nabla (\nabla \cdot \vec{U}) - 2\eta \nabla [(\nabla U)_s] \quad \nabla p = dp = \text{grad } p$$

$$\nabla \cdot \frac{1}{2} (\nabla U + {}^t \nabla U) = \frac{1}{2} \nabla \cdot (\nabla U) + \frac{1}{2} \nabla \cdot {}^t \nabla U$$

$$= \frac{1}{2} \text{grad div } \vec{U} + \frac{1}{2} \text{div grad } \vec{U} = \frac{1}{2} \Delta U \text{ for the incompressible fluid } F.$$

$$\nabla \cdot \vec{T} = -\nabla p - \eta \Delta \vec{U}$$

$$\vec{\Gamma}_m = \vec{f} - \frac{1}{\rho} \nabla p + \frac{\eta}{\rho} \Delta \vec{U} - \text{div } \rho \cdot \overline{v \otimes v}; \quad \frac{\eta}{\rho} = \nu \text{ is the kinetic viscosity}$$

We note the antagonism between the viscosity term and those of turbulence. This fine partial differential equation do not reveal the product of vortex associated at a rate turbulence. However the Navier's equation governing the mean motion give a local spatio-temporal law on $\vec{\omega} = \text{rot } \vec{U}$

$$\frac{\partial \vec{U}}{\partial t} + \overline{d\vec{U}} \cdot \vec{U} = \vec{F} - \frac{1}{\rho} \nabla p + \nu \Delta \vec{U} \quad (I); \text{ taking rot } (I)$$

$$\frac{\partial \vec{\omega}}{\partial t} + \text{rot} \left[\overline{d\vec{U}} \cdot \vec{U} \right] = \text{rot } \vec{F} - \frac{1}{\rho} \text{rot } \nabla p + \nu \Delta \vec{\omega}$$

$$\frac{\partial \vec{\omega}}{\partial t} + \text{grad } \vec{\omega} \cdot \vec{U} - \text{grad } \vec{U} \cdot \vec{\omega}$$

$$\frac{\partial \vec{\omega}}{\partial t} + \text{grad } \vec{\omega} \cdot \vec{U} = \frac{D\vec{\omega}}{Dt} = \text{grad } \vec{U} \cdot \vec{\omega} + \nu \Delta \vec{\omega}$$

Taking scalar product with $\vec{\omega}$

$$\vec{\omega} \cdot \frac{D\vec{\omega}}{Dt} \equiv \vec{\omega} \cdot \text{grad } \vec{U} \cdot \vec{\omega} \Rightarrow \frac{1}{2} \frac{d\omega^2}{dt} = A\omega^3 \text{ and after integration } \frac{\omega}{\omega_0} = \frac{t_0}{t_0 - t}$$

The turbulence premises appear with the critical time t_c . Above this threshold, the vortex increase strongly. Such a threshold have been study in the General Epidemic Process (Boccara, 1992). The analysis of various scale energy transfer through a vortices cascade, up to viscous dissipation, gives a modeling that we can transpose it, in biology. The modeling of expending turbulence is evolved by means of confrontation of dynamical active regions, in vorticellar areas. In some regions rotation control the strain, and in other we have the opposite behavior. These results confirm us in the necessity of a scale analysis, revealing cooperative or antagonists effects, and a return upon hypothesis about dynamic or probabilistic inhibitor sketches at main stages of modeling.

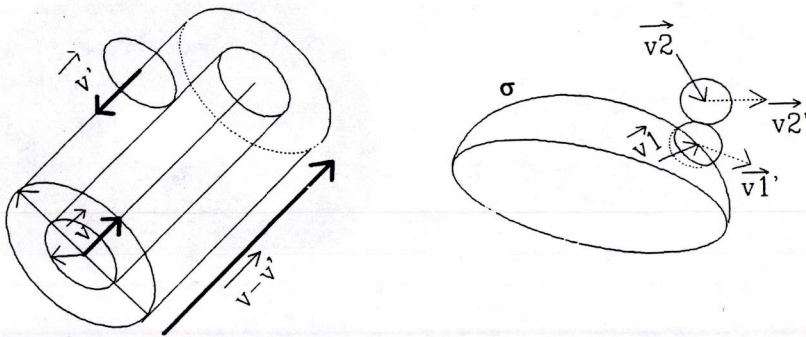

Fig. 1. Free mean path.

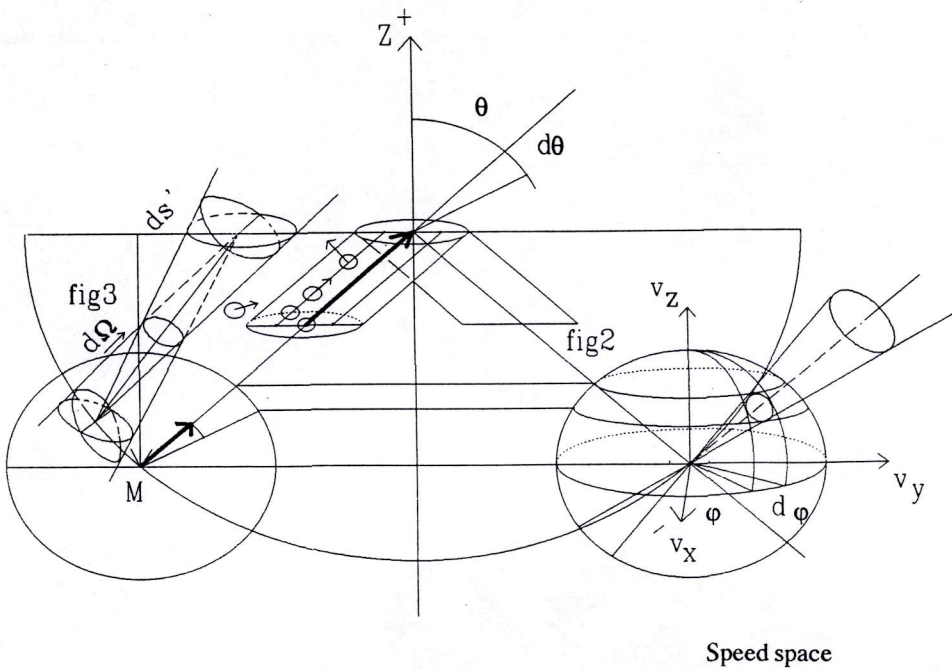
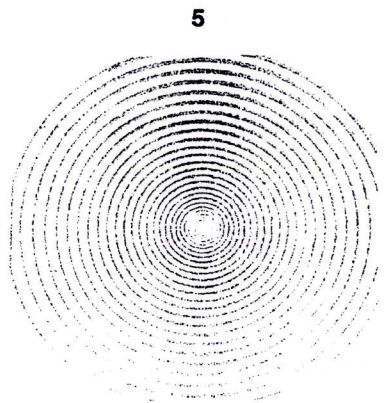
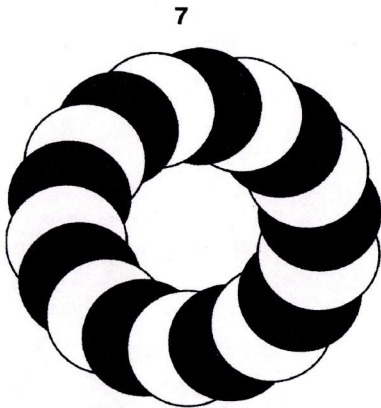
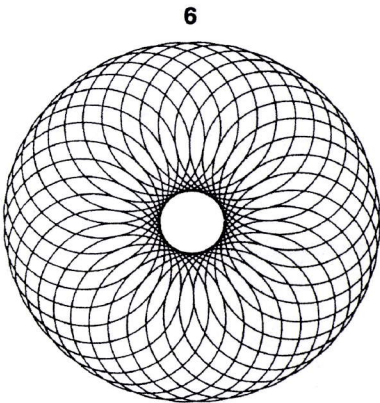
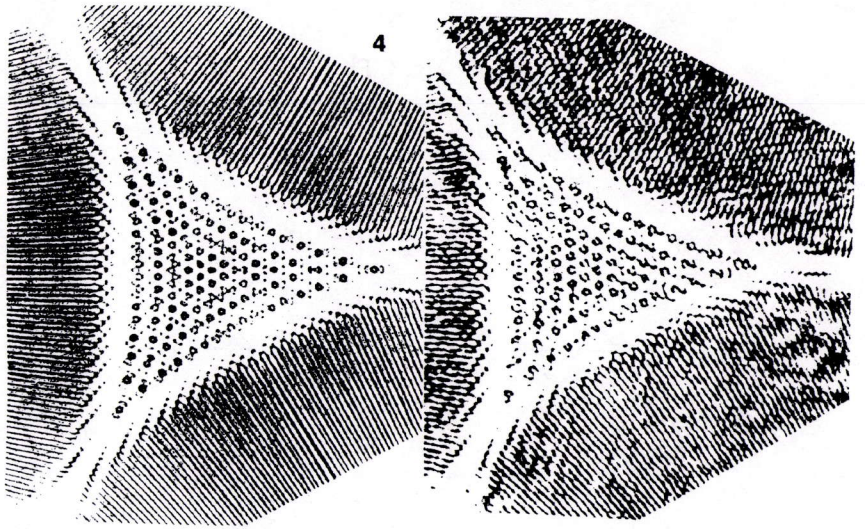
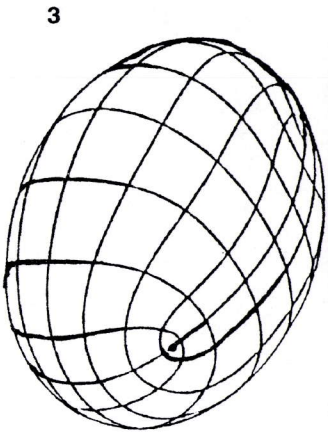
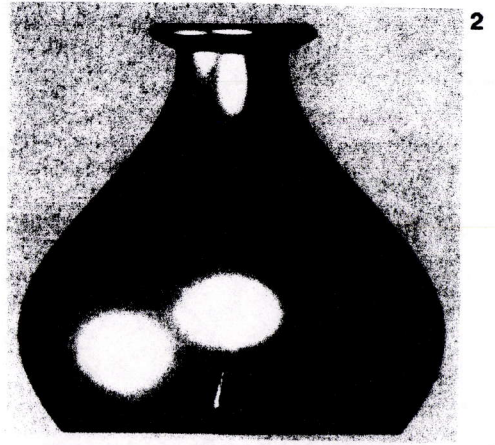
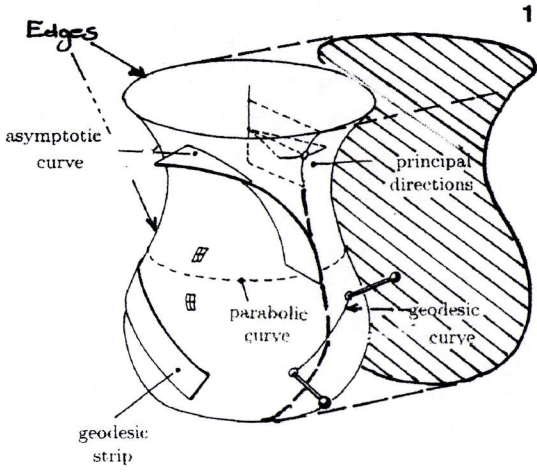

Fig. 2. Geometrical modelling of the kinematic of the momentum transfert.



Conclusion :

A many-body description has been suggested for describing the time evolution of space-dependent epidemics. A set of equation has been derived for the probability densities of the numbers and positions of the different types of individuals involved in the epidemic process. The suggested theory is only on the first stage of development and its potential is far from being exhausted. Further research should precise the study of the different regimes of the dynamics (e.g. the migration processes).

Aknowledgements

Our thanks to Claire Leschi (Laboratoire RFV, INSA Lyon) for her help.

Bibliography :

- Bailey, N.T.J.** (1957), *The Mathematical Theory of Infectious Diseases and its Applications*. London : Charles Griffin & co. Ltd. 413 p.
- Barlett, M.S.** (1955), *Stochastic Processes*. Cambridge : University Press. 390 p.
- Bergé, P., Pommeau, Y., Vidal, C.** (1984), *L'ordre dans le chaos*. Enseignement des sciences. Paris : Hermann. 352 p.
- Blanc-Lapierre, A.** (1963), *Processus de Markov*. Paris : Ed. CNRS. 375 p.
- Blanc-Lapierre, A.** (1963), *Modèles statistiques*. Paris : Masson. 325 p.
- Boccara, N., Cheong, K.** (1992), Automata network SIR models for the spread of infectious diseases in population of moving individuals. *J. Phys. A. : Math. Gen.* Vol. 25 p. 2447-2461.
- Couture, Zitoune** (1995), *Physique statistique*. Paris : Hermann.
- Favre, A., Guitton, H. et J. Lichnerowicz, A. Wolf, E.** (Ed.), (1988), De la causalité à la finalité. A propos de la turbulence. *Coll. Recherches Interdisciplinaires*. Paris : Maloine. 246 p.
- Glandsdorff, P., Prigogine, I.** (1971), *Structures, Stabilités et Fluctuations*. Paris : Masson. 364 p.
- Kahan, T.** (1960), *Physique théorique*. Paris : Presses Universitaires de France. p.
- Källén, A., Arcuri, P., Murray, J.D.** (1985), A simple model for the spatial spread and control of rabies. *J. Theor. Biol.* Vol. 116 p. 377-393.
- Kermack, W.O., Mac Kendrick, A.G.** (1927), A contribution to the mathematical theory of epidemics. *Proc. Roy. Soc. A.* Vol. 115 p. 700-721.
- Kuulasmaa, K.** (1982), The spatial general epidemic and locally dependant random graphs. *J. Appl. Prob.* Vol. p. 745-758.

- Lachal, P.** (1992), *Etude des trajectoires du mouvement brownien*. Doct. d'Université : Univ. Lyon I, Cl. Bernard. 184 p.
- Landau, L., Lifchitz, F.** (1990), *Mécanique des fluides*. Physique théorique. Moscou : Editions MIR. 520 p.
- Landau, L., Lifchitz, F.** (1990), *Physique statistique*. Physique théorique. Moscou : Editions MIR. 484 p.
- Nozières, P.** (1977), *Adiabaticisme et dissipation*. Paris : CNRS.
- Murray, J.D.** (1993), *Mathematical Biology*. Biomathematics Texts. Heidelberg : Springer-Verlag. 590 p.
- Vidal, C., Dewel, G., Borckmans, P.** (1994), *Au delà de l'équilibre*. Enseignement des sciences. Paris : Hermann. 372 p.
- Vogel, Th.** (1973), *Pour une théorie mécanique renouvelée. Mécanique héréditaire*. Paris : Gauthier Villiar.